



# °LAUDA

## OVERALL BROCHURE CONSTANT TEMPERATURE EQUIPMENT 2019/2020

°FAHRENHEIT. °CELSIUS. °LAUDA.

# THE COMPLETE SPECTRUM OF PERFECT TEMPERATURE CONTROL.

LAUDA is the world's leading provider of high-precision temperature control with liquids. We have satisfied customers worldwide with professional expertise and environmentally friendly concepts time and again for over 60 years. In our company, we always go one step further: We encourage our employees to share their ideas and create space for technical innovation and creative solutions, winning over new markets and customer segments.

[www.lauda.de](http://www.lauda.de)



# LAUDA

## Worldwide

### LAUDA-Noah, LP

2501 SE Columbia Way, Suite 140  
Vancouver, WA 98661 • USA  
T +1 360 993 1395 • [info@lauda-noah.com](mailto:info@lauda-noah.com)

### new.degree, LP

**The LAUDA Innovation Lab**  
440 North Wolfe Road  
Sunnyvale, CA 94085 • USA  
T +1 408 829-5287 • [info@new.degree](mailto:info@new.degree)

### LAUDA-Brinkmann, LP

1819 Underwood Boulevard • Delran, NJ, 08075 • USA  
308 Digital Drive • Morgan Hill, CA 95037 • USA  
T +1 856 7647300 • [info@lauda-brinkmann.com](mailto:info@lauda-brinkmann.com)

### LAUDA América Latina Tecnología Ltda.

Av. Paulista, 726 – 17º andar – Cj. 1707  
01310-910 – São Paulo • SP Brazil  
T +55 11 3192-3904 • [info@lauda.net.br](mailto:info@lauda.net.br)

### LAUDA Ultracool S.L.

C/ Colom, 606 • 08228 Terrassa (Barcelona) • Spain  
T +34 93 7854866 • [info@lauda-ultracool.com](mailto:info@lauda-ultracool.com)

### LAUDA Ibérica Soluciones Técnicas, S.L.

C/ Colom, 606 • 08228 Terrassa (Barcelona) • Spain  
T +34 93 7854866 • [info@lauda-iberica.es](mailto:info@lauda-iberica.es)

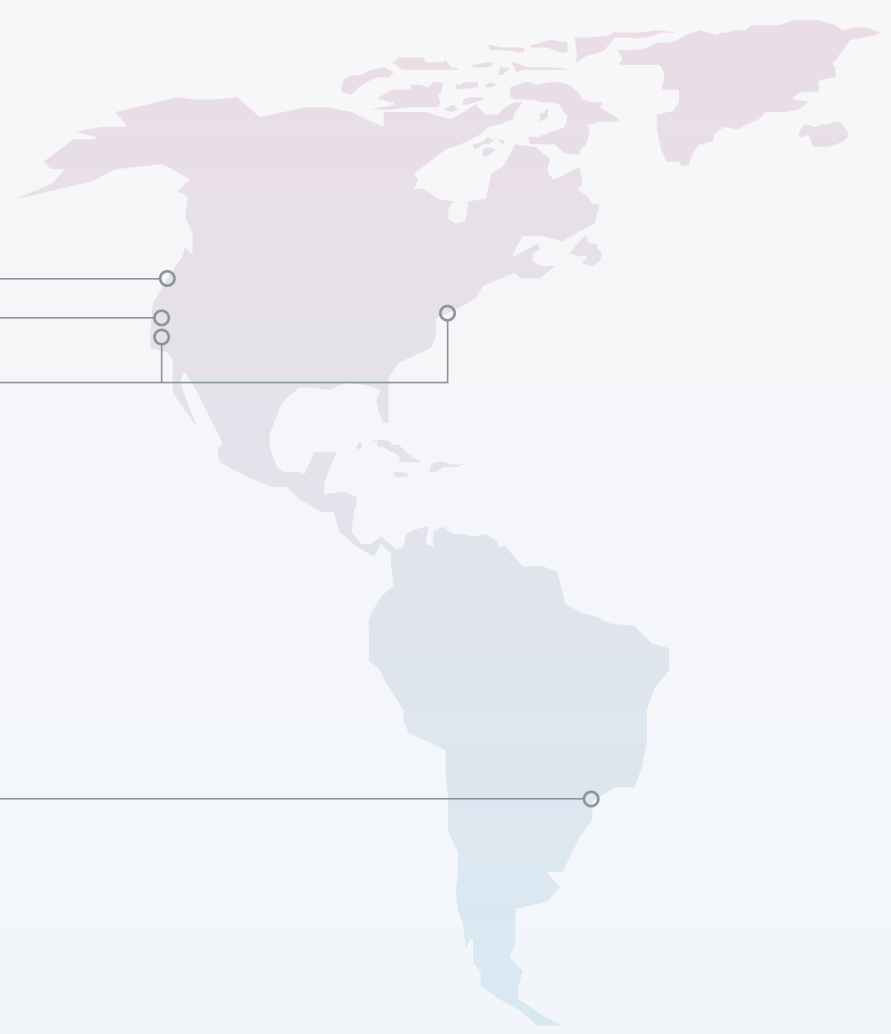

**LAUDA Technology Ltd.**

Tinwell Business Park • Steadfold Lane • Tinwell  
Stamford PE9 3UN • United Kingdom  
T +44 (0)1780 243 118 • info@lauda-technology.co.uk

**GFL Gesellschaft für Labortechnik mbH**

Schulze-Delitzsch-Straße 4 • 30938 Burgwedel  
Germany • T +49 (0) 5139 9958-0 • info@gfl.de

**OOO ›LAUDA Wostok‹**

Malaja Pirogowskaja Str. 5 • 119435 Moscow  
Russia • T +7 495 9376562 • info@lauda.ru

**LAUDA DR. R. WOBSEY GMBH & CO. KG**

Pfarrstraße 41/43 • 97922 Lauda-Königshofen  
Germany • T +49 (0)9343 503-0 • info@lauda.de

**LAUDA Production China Co., Ltd.**

Room A , 2nd floor, Building 6 • No. 201 MinYi Road  
Song Jiang District • 201612 Shanghai • China  
T +86 10 57306210 • info@lauda.cn

**LAUDA China Co., Ltd.**

2nd floor, Building 6 • No. 201 MinYi Road  
Song Jiang District • 201612 Shanghai • China  
T +86 21 64401098 • info@lauda.cn  
Office Beijing • 15/F, Office Building A  
Parkview Green 9 Dongdaqiao Road,  
Chaoyang District • 100020 Beijing • China  
T +86 10 57306210 • info@lauda.cn

**LAUDA Italia S.r.l.**

Strada 6 – Palazzo A – Scala 13  
20090 Assago Milanofiori (MI) • Italy  
T +39 02 9079194 • info@lauda-italia.it

**LAUDA France S.A.R.L.**

ZAC du Moulin • 25 rue Noyer • CS 11621  
95724 Roissy Charles de Gaulle Cedex • France  
T +33 (0)1 39926727 • info@lauda.fr

**LAUDA Singapore Pte., Ltd.**

25 International Business Park • #04-103M German Centre  
Singapore 609916 • Singapore • T +65 6563 0241 • info@lauda.sg

# LAUDA

A world market leader with tradition

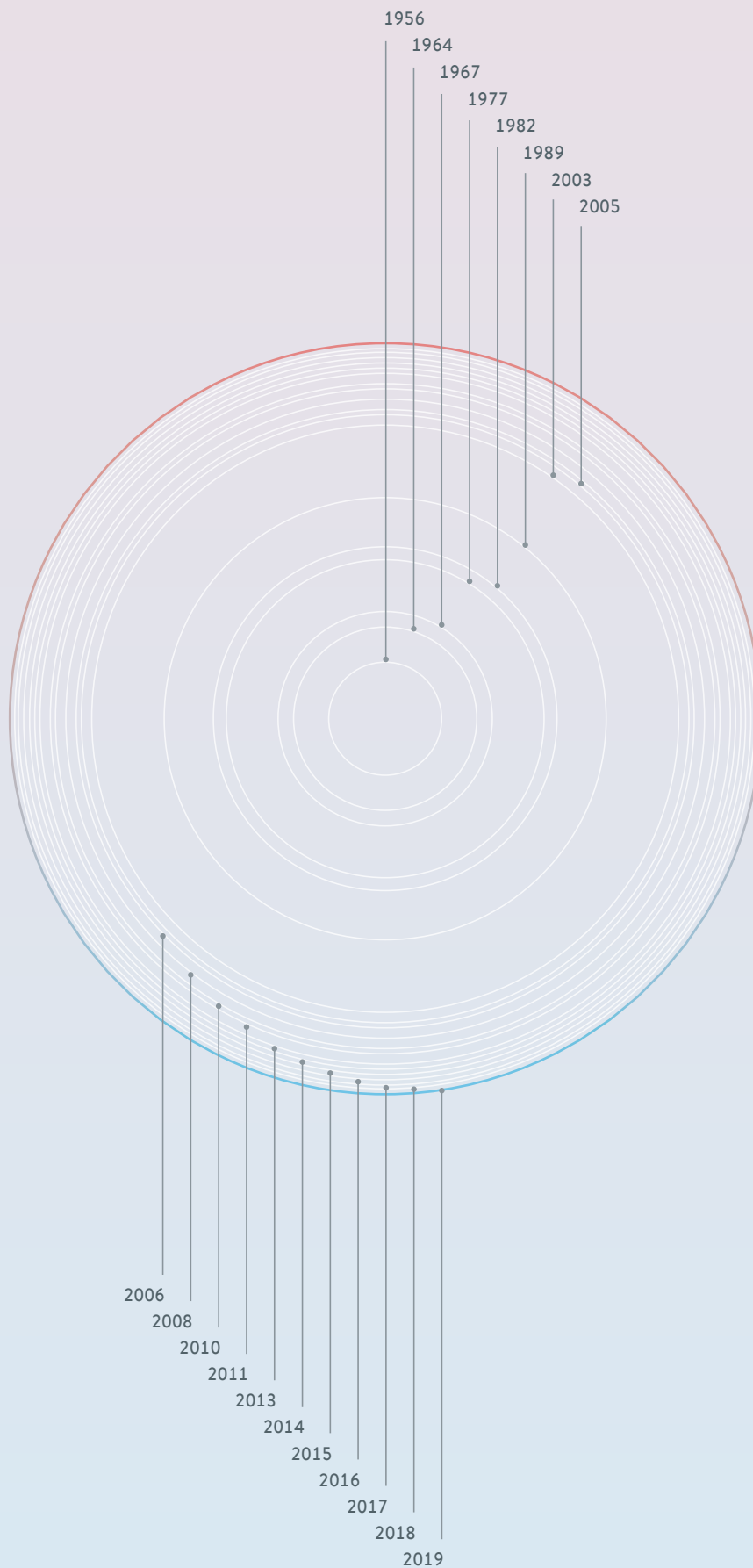

<b>1956</b>	The first year	Dr. Rudolf Wobser founds Messgerätewerk Lauda Dr. R. Wobser KG in the small town of Lauda in Baden.
<b>1964</b>	The first industrial systems	Since 1964, LAUDA has also been building industrial heating and cooling systems for technology centers and production.
<b>1967</b>	The first measuring instruments	Market launch of pioneering LAUDA innovations: such as the first tensiometer and first film weighing scales.
<b>1977</b>	Dr. Gerhard Wobser and Karlheinz Wobser take over the management	After their father's death, the two brothers take up the role of Managing Director and share responsibilities accordingly.
<b>1982</b>	The first thermostat with a microprocessor	LAUDA introduces the world's first thermostats featuring microprocessor technology and invents features such as proportional cooling and external control.
<b>1989</b>	The first year under today's company name	Renaming of company with expansion of product range: from Messgerätewerk Lauda Dr. R. Wobser KG to LAUDA DR. R. WOBSEK GMBH & CO. KG.
<b>2003</b>	Dr. Gunther Wobser appointed Managing Director	Karlheinz Wobser retires. Dr. Gunther Wobser, at LAUDA since 1997, becomes the new Managing Director.
<b>2005</b>	Subsidiary LAUDA France	First subsidiary LAUDA France is founded to support and advise customers and agencies on the market.
<b>2006</b>	50 years of LAUDA	LAUDA celebrates its 50th anniversary on March 1, 2006.
<b>2008</b>	Global expansion phase with new subsidiaries	LAUDA America Latina C.A., LAUDA China Co. Ltd. and LAUDA-Brinkmann, LP, USA, are founded.
<b>2010</b>	Dr. Gerhard Wobser resigns	His son, Dr. Gunther Wobser, takes over his duties.
<b>2011</b>	Acquisition of LAUDA Ultracool	LAUDA expands its product range with industrial circulation chillers by acquiring LAUDA Ultracool S.L. in Barcelona.
<b>2013</b>	New building	Opening of a new logistics center and production hall.
<b>2014</b>	Expansion LAUDA-Noah	LAUDA buys US company Noah Precision and expands the product range with thermo-electric thermostats.
<b>2015</b>	Independent company for measuring devices	The new subsidiary LAUDA Scientific takes over development, sales and service activities for LAUDA measuring.
<b>2016</b>	LAUDA celebrates its 60th birthday	On March 1, 2016, LAUDA celebrated its 60th company anniversary.
<b>2017</b>	Progress with Peltier technology	An innovative thermo-electric circulation thermostat, the LAUDA LOOP, enables location-independent temperature control.
<b>2018</b>	New branding for LAUDA	LAUDA is introducing a confident new corporate design with a redesigned logo and new slogan.
<b>2019</b>	Acquisition of GFL and new device design	With the purchase of traditional company GFL Gesellschaft für Labortechnik, LAUDA is expanding its expertise in the field of lab temperature control. At the same time, LAUDA is setting new benchmarks in device design with the introduction of the new Integral product line.

# LAUDA

## Applications according to sectors

### RESEARCH AND DEVELOPMENT LABORATORIES

---



In research and development, temperature control is particularly important in the areas of sample preparation and quality assurance. As part of the sample preparation, a pre-tempering takes place in many cases. Many processes in quality assurance require the observance of a defined temperature or the targeted change of the temperature in a defined time.

#### Typical applications

- Sample preparation
- Quality assurance
- Research laboratory

### AUTOMOTIVE

---



Temperature control in the automotive sector is mainly found in test benches and material tests. All components of the automobile are exposed to particularly high temperature fluctuations. Great importance is attached to component testing on special test benches. The simulation of environmental conditions such as high or low temperatures is an important part of material testing.

#### Typical applications

- Test bench applications
- Material testing

### BIOTECHNOLOGY

---



In biotechnology, temperature control is essential to the quality of research and production results. Constant temperatures in the operation of bioreactors contribute significantly to the success of the products. As part of sample preparation, there are a variety of work steps that require reliable temperature control.

#### Typical applications

- Bioreactors
- Sample preparation

### CHEMISTRY

---



In the chemical industry, there are many processes where temperature control plays an important role, including reactor temperature control and process engineering. At tempering processes in reactors, applications such as chemical reactions, syntheses, production of drug substances, polymerizations or crystallizations take place.

#### Typical applications

- Reactor temperature control
- Process engineering



## PHARMACEUTICAL INDUSTRY

---



In the pharmaceutical industry, the temperature control processes range from research to production scale. To obtain high-quality reaction products, temperature control systems must reliably control the process sequence in an external reactor.

### Typical applications

- Reactor temperature control
- Process engineering

## SEMICONDUCTOR INDUSTRY

---



In the production of semiconductors and the testing of electronic components, there are numerous processes that must be exactly tempered. These include, for example, the organometallic chemical vapor phase deposition (MOCVD) in semiconductor coating as a precursor of LED production. Other typical temperature-dependent investigations in the semiconductor industry include stress tests for function and load testing, environmental simulations, and in-circuit tests of electronic assemblies.

### Typical applications

- Process cooling
- Component testing

## AEROSPACE

---



Temperature simulations and temperature-dependent material tests are an important component in the aerospace industry. Cyclic temperature stress tests ensure that a trouble-free usage of the components used is always ensured, even under extremely fluctuating external conditions in space.

### Typical applications

- Material testing
- Temperature simulation

## MEDICAL TECHNOLOGY

---



In medical technology, temperature control is found primarily in the laboratory for sample preparation and in medical devices such as imaging machines, medical lasers or devices used in pharmaceutical and medical laboratories.

### Typical applications

- Medical laboratory
- Medical device

# LAUDA Group

## The essential facts

For more than 60 years, we have been the only company in the world to guarantee the perfect temperature in research, application technology and production for more than 10,000 customers with our 500 employees, a turnover of more than 90 million euro and twelve subsidiaries overseas. LAUDA quality products control temperature with up to 400 kilowatts of cooling capacity and maintain constant temperatures or heat to the nearest five-thousandth of a °C within a range of -150 to 550 °C.

# 90.000.000

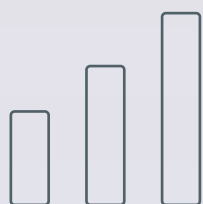

Revenue in euro

# 500

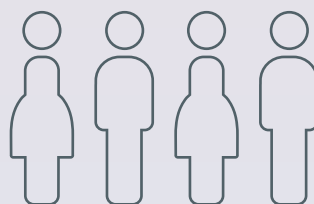

Employees

# 95

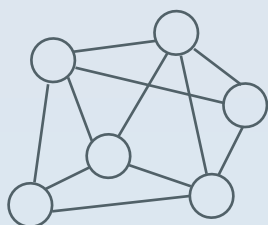

Number of representatives

# 12



Foreign subsidiaries

42%

Constant temperature  
Equipment

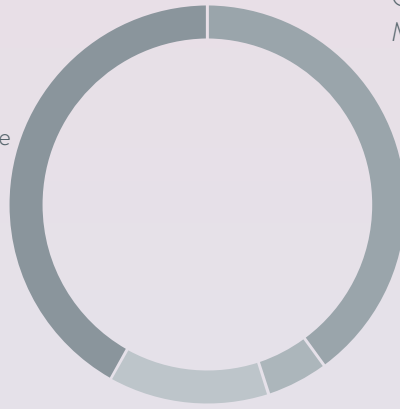

40%

Original Equipment  
Manufacturer

5%

LAUDA Scientific

13%

Heating and cooling systems

Portion of overall turnover 2018

## Business units

### CONSTANT TEMPERATURE EQUIPMENT

From water baths to high-performance process thermostats: LAUDA thermostats are characterized by their excellent handling, highly ergonomic design and intuitive operation and provide a working temperature range from  $-100$  to  $320^{\circ}\text{C}$ .

### HEATING AND COOLING SYSTEMS

Heating and cooling to the accuracy of a tenth degree in a temperature range from  $-150$  to  $550^{\circ}\text{C}$ : with tailor-made systems for industrial applications according to modular engineering principles.

### SERVICE

High product quality and comprehensive professional services form an inseparable unit at LAUDA. Regular care, service and maintenance by highly qualified LAUDA service specialists ensures the high performance of your LAUDA devices.

### ORIGINAL EQUIPMENT MANUFACTURER

Customer-specific advice with corresponding instrument selection and development of individual temperature control solutions for an optimum cost-benefit ratio with decades of successful partnerships.

### LAUDA SCIENTIFIC

Reliable measuring instruments for the high-precision analysis of polymers, plastics, oils and surfactants – precisely tuned to the current needs of customers and the market.

### GFL – GESELLSCHAFT FÜR LABORTECHNIK

GFL has been known as a premium manufacturer of laboratory technology for more than 50 years. Its comprehensive portfolio, ranging from deep freezers to incubators, is used in research, routine and special laboratories in medicine, science and industry.

# LAUDA WINS OVER: WITH PRODUCTS, SAFETY AND SERVICE – AND PEACE OF MIND.



## Large selection

Whether it's for routine tasks, professional and economical temperature control, high cooling outputs and high cooling rates or lightning-fast temperature changes – LAUDA has the right solution for almost every requirement.



## Exemplary safety concepts

All products meet the most stringent safety requirements and provide peace of mind in every application, thanks to the intelligent technologies and sophisticated safety concepts.



## Easy handling

All LAUDA devices are characterized by excellent handling, a highly ergonomic design and intuitive operation. They also offer maximum user convenience and future-oriented software.



## First-class advice – internationally

The LAUDA team provides friendly, fair, and expert advice. LAUDA application experts help customers worldwide to configure application-optimized systems.



## Proverbial quality

For more than 60 years, LAUDA has been developing, designing and producing high-quality constant temperature equipment to the highest standards in quality and safety – confirming time and again the durability and longevity that LAUDA has become known for.



## Reliable service

Robust LAUDA devices are known for their durability. If you still need additional support, we will not let you down: with quick access to comprehensive services – for greater flexibility and cost-efficiency.



# LAUDA

## Overview



### WATER BATHS

Aqualine P.18



### HEATING THERMOSTATS

Alpha P.24

ECO P.26

PRO P.28

Proline Bridge thermostats P.30

Proline Clear-view thermostats P.32



### COOLING THERMOSTATS

Alpha P.48

ECO P.50

PRO P.52

Proline Kryomate P.54

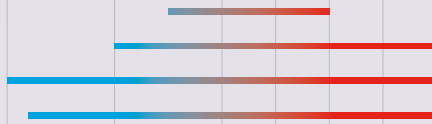

### CIRCULATION AND PROCESS THERMOSTATS

LOOP P.72

PRO P.74

Integral T P.76

Integral XT P.78

Variocool P.80

Kryoheater Selecta P.82

POU P.84

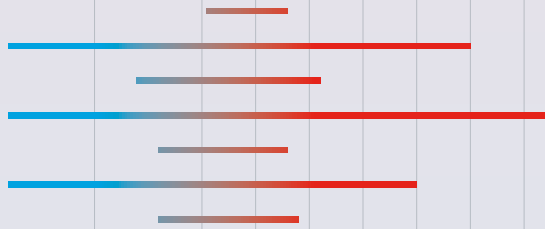

### CIRCULATION CHILLERS

Microcool P.108

Variocool P.110

Ultracool P.112

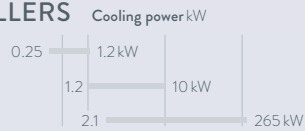

### CALIBRATION THERMOSTATS

Ecoline P.130

Proline P.132

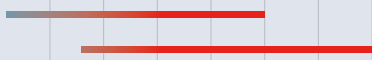

### ADDITIONAL EQUIPMENT

Flow through coolers P.140

Immersion coolers P.142

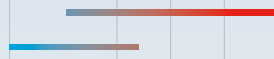

### HEAT TRANSFER LIQUIDS P.146

### ACCESSORIES P.148

# LAUDA WATER BATHS

## Specific application examples

---

- Medical samples for analysis
- Dental technology
- Cytology





# LAUDA Aqualine

Universal water baths

from 25 to 95 °C for the lab

25 °C  95 °C

## Reliable and ergonomic water baths

Cost-effective, compact water baths for basic use in the lab, LAUDA Aqualine is sure to impress with its ease of operation made possible by digital LED display and high reliability. With maximum usable space and no obstructions in the bath, the devices are easy to clean or disinfect. The panel heating elements installed under the bath vessel ensure homogeneous temperature distribution without local overheating.



Full use of the bath and easy cleaning of the inner chamber, thanks to the lack of obstructions in the bath vessel



Removable, transparent gable cover

## HEATING PERFORMANCE Heat transfer liquid: Water, bath closed

Bath temperature °C

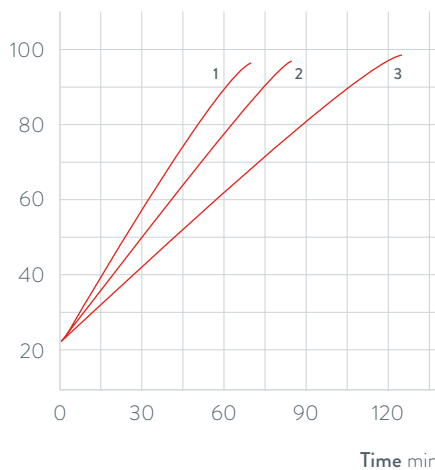

1 AL 5 | AL12  
2 AL 18  
3 AL 25

## Important functions

- Large, optimally designed bath vessels
- Optimized shape of standard gable cover prevents contamination of samples by dripping condensation
- Integrated overtemperature protection

## Included accessories

Transparent plastic gable cover

## Further accessories

Racks

All technical data and power supply variants can be found in the »Technical data« section.

More at [www.lauda.de/1720](http://www.lauda.de/1720)



### LAUDA Aqualine

The four different water bath sizes of the LAUDA Aqualine, made of deep-drawn stainless steel without obstructions, offer optimum utilization of the inner space and a maximized sample count per bath. It offers the perfect bath depth or opening for every application, regardless of the sample size and quantity. The patented heating concept allows Aqualine baths to achieve outstanding temperature homogeneity and make them especially well-suited to the needs of biological, medical, or biochemical labs.



# LAUDA Water baths

## Device type overview

LAUDA Aqualine / Page 18



# LAUDA Water baths

## Technical data according to DIN 12876 standard

Device type	Working temperature range °C	Working temperature range with water cooling °C	Operating temperature range °C	Temperature stability ±K	Safety fittings	Heater power max. kW	Pump type	Pump pressure max. bar	Pump suction max. bar	Pump flow max. pressure L/min	Pump flow max. suction L/min	Pump connection thread mm	Nipples Øe	Bath volume min. L	Bath volume max. L	Bath opening (W x D) mm
AL 5	25...95	-	25...95	0.20	I, NFL	0.5	-	-	-	-	-	-	-	1.0	5.0	300×151
AL 12	25...95	-	25...95	0.20	I, NFL	1.0	-	-	-	-	-	-	-	2.0	12.0	329×300
AL 18	25...95	-	25...95	0.20	I, NFL	1.2	-	-	-	-	-	-	-	3.0	18.0	505×300
AL 25	25...95	-	25...95	0.20	I, NFL	1.2	-	-	-	-	-	-	-	3.0	25.0	505×300

LAUDA Aqualine / Page 18

# LAUDA Water baths

## Power supply variants

Device type	Power supply V; Hz	Heater power max. kW	Loading max. kW	Plug code*	Cat. No.	Device type	Power supply V; Hz	Heater power max. kW	Loading max. kW	Plug code*	Cat. No.
-------------	--------------------	----------------------	-----------------	------------	----------	-------------	--------------------	----------------------	-----------------	------------	----------

### LAUDA Aqualine / Page 18

AL 5	100 V; 50/60 Hz	0.3	0.4	14	L000614	AL 18	100 V; 50/60 Hz	0.9	1.0	14	L000616
AL 5	115 V; 60 Hz	0.5	0.5	14	L000609	AL 18	115 V; 60 Hz	1.2	1.3	14	L000611
AL 12	100 V; 50/60 Hz	0.8	0.8	14	L000615	AL 25	100 V; 50/60 Hz	0.9	1.0	14	L000617
AL 12	115 V; 60 Hz	1.0	1.1	14	L000610	AL 25	115 V; 60 Hz	1.2	1.3	14	L000612

Bath depth mm	Usable depth mm	Height top of bath mm	Dimensions (W x D x H) mm	Weight kg	Power supply V; Hz	Loading max. kW	Cat. No.	Device type
150	130	234	343×186×290	5.0	230 V; 50/60 Hz	0.5	L000594	AL 5
150	130	234	372×335×325	8.5	230 V; 50/60 Hz	1.1	L000595	AL 12
150	130	234	548×335×325	11.5	230 V; 50/60 Hz	1.3	L000596	AL 18
200	180	284	548×335×375	13.5	230 V; 50/60 Hz	1.3	L000597	AL 25

\*All data for the plug codes can be found on page 150

# LAUDA HEATING THERMOSTATS

## Specific application examples

---

- Sample preparation for chemical and pharmaceutical analysis
- Medical serology
- Biotechnology
- Material testing





# LAUDA Alpha

Heating thermostats from 25 to 100 °C for cost-effective temperature control thermostating in the lab

25°C ————— 100°C

## Cost-effective thermostats with reliable technology incorporated into a modern design

LAUDA Alpha is the most cost-effective choice when it comes to premium-quality LAUDA thermostats. These reliable and user-friendly thermostats, with features optimized to the essentials, can be operated with non-flammable liquids and are suitable for both internal and external temperature control tasks.



Simple and intuitive menu navigation with three-button operation using a large, clearly legible LED display



Screw clamp allows easy change to different bath vessels with a maximum wall thickness of 30 mm

## HEATING PERFORMANCE Water, bath closed

Bath temperature °C

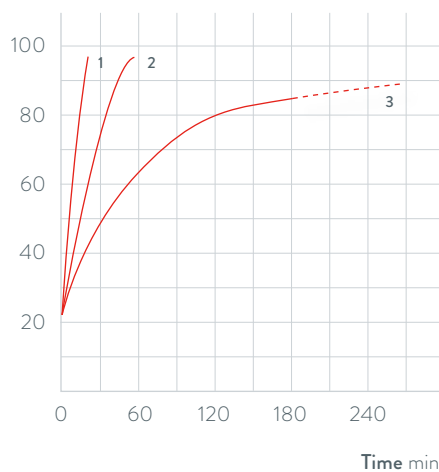

1 A6  
2 A12  
3 A24

## Important functions

- Deep-drawn stainless steel bath vessels
- Integrated timer function allows automatic device shutdown
- Low-level and overtemperature protection for operation with non-flammable liquids

## Included accessories

Screw clamp, attachment nozzle in two sizes

## Further accessories

Pump circulation set, cooling coil, bath cover set

All technical data and power supply variants can be found in the ›Technical data‹ section.

More at [www.lauda.de/1724](http://www.lauda.de/1724)





### LAUDA Alpha

Heating thermostats A6, A12 and A24 work in the temperature range between 25 and 100 °C. Cooling coil, pump circulation set and bath cover set are available as accessories for all thermostats.



# LAUDA ECO

Heating thermostats from 20 to 200 °C  
for economic temperature control in the lab



## Economic and high-performance temperature control

The ECO thermostats come in Silver (LCD display) or Gold (color TFT display) models, equipped with a mini USB interface as standard. The circulation pump can be adjusted to six levels. The ECO heating thermostat line encompasses transparent baths up to 100 °C as well as immersion thermostats and heating thermostats with stainless steel baths up to 200 °C.

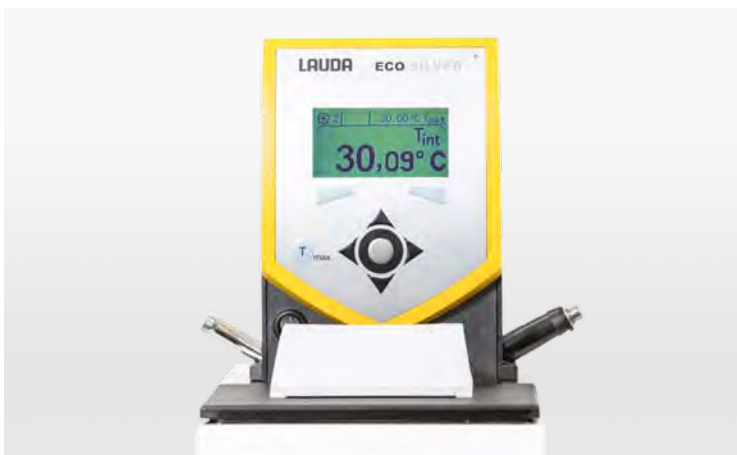

Plain text menu navigation on a monochrome LCD (Silver) or color TFT display (Gold) for easy operation



Standard-issue cooling coil included with all heating thermostats

## HEATING PERFORMANCE Heat transfer liquid: Therm 240, bath closed

Bath temperature °C

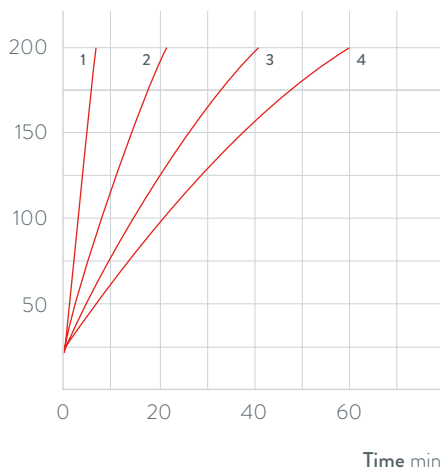

- 1 E 4 G
- 2 E 10 G
- 3 E 20 G
- 4 E 25 G

## Important functions

- Integrated programmer for automating temperature profiles
- Adjustment of flow rate switch for internal/external circulation, can be controlled from exterior during operation
- Can be upgraded with Pt100/LiBus module for external control

## Included accessories

Cooling coil, bath cover and pump connections (with E 4)

## Further accessories

Tubing, bath cover, pump connection set, interface modules

All technical data and power supply variants can be found in the ›Technical data‹ section.

More at [www.lauda.de/1726](http://www.lauda.de/1726)



## LAUDA ECO

Bath thermostats come equipped with a cooling coil as standard. The E4 is also equipped with a bath cover and pump connections for external application connections. A drain tap on the back side of the device makes changing the heat transfer liquid in the stainless steel baths easy and safe.



# LAUDA PRO

Heating bath thermostats from 30 to 250 °C  
for professional temperature control

30°C ————— 250°C

## Flexible operation, outstanding performance characteristics

LAUDA PRO is the cutting-edge product line with an outstanding overall concept: The innovative Base or Command Touch operating units can be detached and used as a remote control. Heating bath thermostats come equipped with a cooling coil as standard.



Low device height and 360° accessibility of the bath thanks to detachable remote control



Draining tap on the front of the device

## HEATING PERFORMANCE Heat transfer liquid: Ultra 300, bath closed

Bath temperature °C

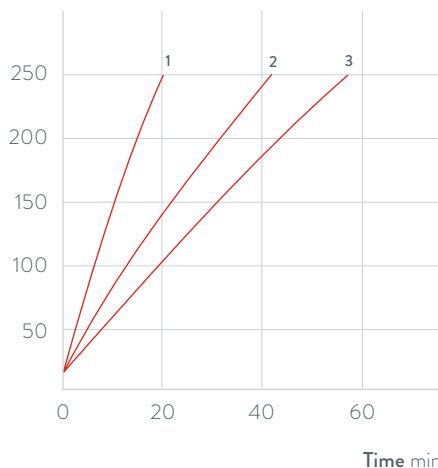

1 P10 C  
2 P20 C  
3 P30 C

## Important functions

- Ethernet and USB interface and Pt100 connection as standard
- Operated via Base operating unit with OLED display or Command Touch with color touch screen
- Stainless steel bath vessels (insulated with handles and drain tap)
- Internal LAUDA Vario Pump with 8 selectable output levels

## Included accessories

Bath cover, tubing nipples with screw caps for the cooling coil

## Further accessories

External pump, interface modules

All technical data and power supply variants can be found in the ›Technical data‹ section.

More at [www.lauda.de/1728](http://www.lauda.de/1728)



## LAUDA PRO

The PRO heating bath thermostats P10, P20 and P30, with volumes of 10, 20 and 30 liters, function up to a maximum temperature of 250 °C and their excellent temperature stability make them perfect for internal bath applications.



# LAUDA Proline bridge thermostats

Bridge thermostats 30 to 300 °C  
for temperature control of any bath

30°C  300°C

## Intuitive operation with broad temperature range

The LAUDA Proline bridge thermostats with vario flex pump are great for temperature control of any bath vessel. The PB models have a pressure/suction pump, but the PBD models are equipped with stronger pressure pumps. They enable temperature control on deeper baths of up to 320 mm. A telescoping rod for baths with a width of 310 to 550 mm, an ergonomic handle and side pump connections are also available.

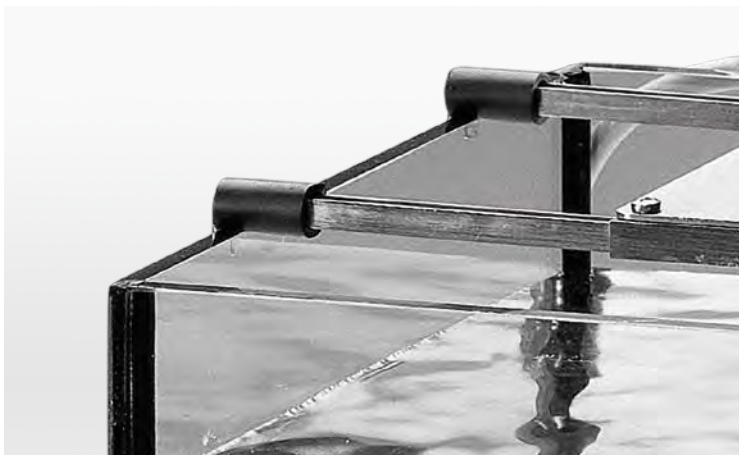

Extendable telescoping rods for placement on baths with widths of 310 to 550 mm



Removable Command remote control unit for easy and intuitive operation

## PUMP CHARACTERISTICS for PB and PBC, Liquid: Water

Pressure bar

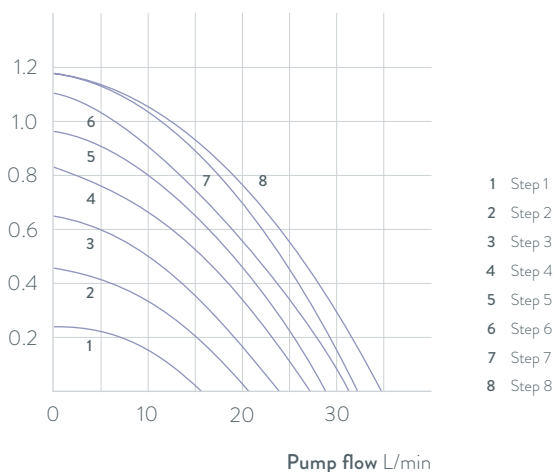

- 1 Step 1
- 2 Step 2
- 3 Step 3
- 4 Step 4
- 5 Step 5
- 6 Step 6
- 7 Step 7
- 8 Step 8

## Important functions

- Programmer with 150 temperature/time segments and graphical temperature display with Command control unit
- PowerAdapt system for optimally adapted max. heating output without influencing the mains power supply
- Low-level protection and adjustable overtemperature protection with acoustic alarm. Float for identifying low or high level

## Included accessories

Tubing nipples for pump connection, telescoping rod

## Further accessories

Automatic filling device, bath vessels, interface modules

All technical data and power supply variants can be found in the ›Technical data‹ section.

More at [www.lauda.de/1730](http://www.lauda.de/1730)

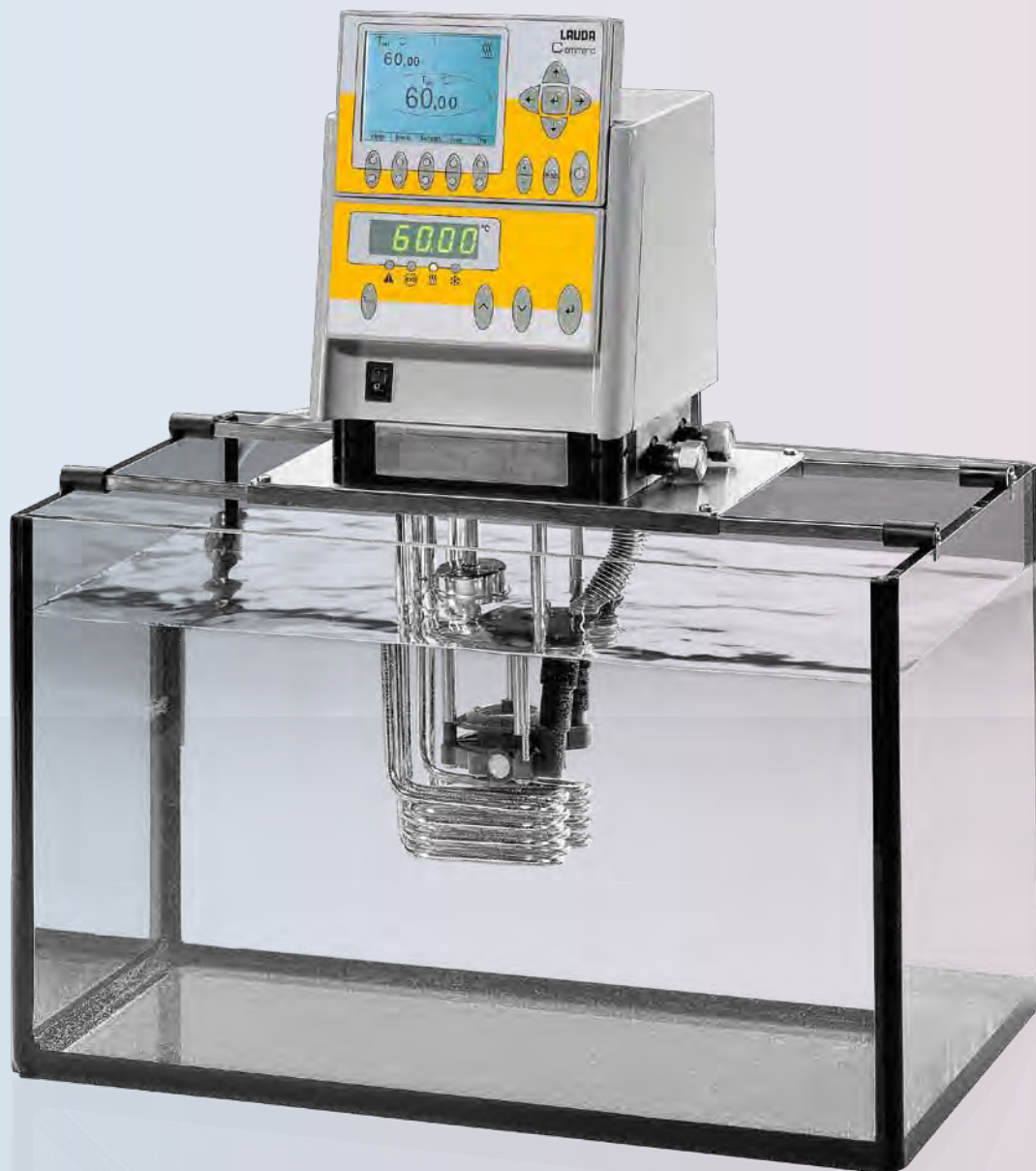

### LAUDA Proline bridge thermostats

LAUDA Proline bridge thermostats are available with two different control units. The master version is designed for all applications in which the parameters are not changed very often. The removable Command operating unit offers a graphic LCD screen for high operating convenience and an additional programmer.



# LAUDA Proline clear-view thermostats

Heating clear-view thermostats from 30 to 230 °C for professional use in research, application technology and production

30°C  230°C

## A clear view of the object at all times

LAUDA clear-view thermostats are optimized for direct observation of objects. They are ideal for use with the fully automatic LAUDA viscometer PVS or iVisc, since the temporal and spacial temperature stability necessary for precise determination of viscosity is guaranteed across the whole temperature range. Furthermore, the two-chamber principle ensures a constant liquid level in the measuring chamber at all times, regardless of the fluid volume and temperature. The PVL models with five layers of insulated glass are suitable for low temperature measurements down to -40 or -60 °C when a flow through chiller or cooling thermostat is connected.



Insulated glass makes it possible to observe samples, even at very low temperatures



Removable Command remote control unit for easy and intuitive operation

## HEATING PERFORMANCE Heat transfer liquid: Therm 240, bath closed

Bath temperature °C

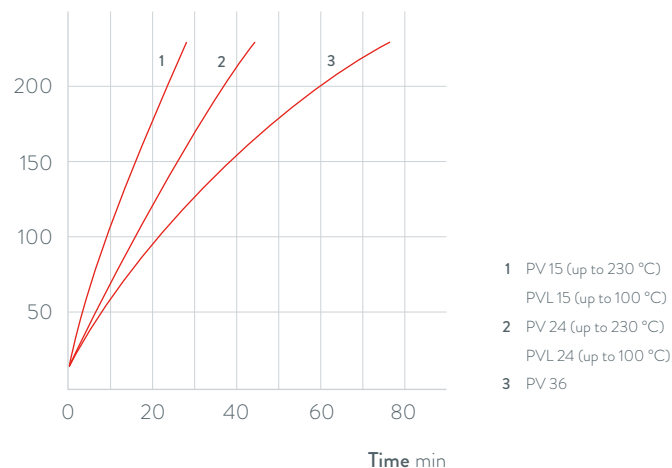

- 1 PV 15 (up to 230 °C)  
PVL 15 (up to 100 °C)
- 2 PV 24 (up to 230 °C)  
PVL 24 (up to 100 °C)
- 3 PV 36

## Important functions

- Programmer with 150 temperature/time segments and graphical temperature display with Command control unit
- LAUDA Vario Flex pump (pressure pump) with eight selectable output levels
- Cooling coil fitted as standard allows connection of an additional cooler

## Included accessories

Tubing nipples for pump connection and cooling coil

## Further accessories

Solenoid valve for cooling water, additional cooler, interface modules

All technical data and power supply variants can be found in the »Technical data« section.

More at [www.lauda.de/1732](http://www.lauda.de/1732)





### LAUDA Proline clear-view thermostats

LAUDA Proline clear-view thermostats are available with two different control units. The master version is designed for all applications in which the parameters are not changed very often. The removable Command operating unit incorporates a graphic LCD screen for high operating convenience and also a programmer.



# LAUDA Heating thermostats

## Device type overview

LAUDA Alpha / Page 24



A



A 6



A 12



A 24

LAUDA ECO / Page 26



E 4 G



E 10 G



E 20 G



E 25 G



E 40 G



Gold

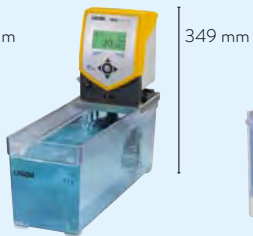

ET 6 S

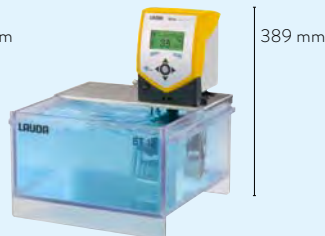

ET 12 S



ET 15 S



ET 20 S

LAUDA PRO / Page 28



P 10  
P 20 (D 475 mm)  
P 30 (D 600 mm)



P 10 C  
P 20 C (D 475 mm)  
P 30 C (D 600 mm)

# LAUDA Heating thermostats

## Interfaces

	Pt 100	USB	Ethernet	RS 232 / 485	Analog	Namur contact	Sub-D contact	Profibus	EtherCat M8	EtherCat RJ 45	Number of module slots, large	Number of module slots, small
LAUDA Alpha / Page 24	-	-	-	-	-	-	-	-	-	-	-	-
LAUDA ECO / Page 26	Z	S	Z	Z	Z	Z	Z	Z	Z	Z	1	1
LAUDA PRO / Page 28	S	S	S	Z	Z	Z	Z	Z	Z	Z	1	-
LAUDA Proline Master	S	-	Z	Z	Z	Z	Z	Z	Z	Z	2	-
LAUDA Proline Command / Page 31	S	-	Z	S	Z	Z	Z	Z	Z	Z	2	-

S = Series standard

Z = Available as an accessory



LRZ 912  
Analog module



LRZ 913  
RS 232/485  
interface



LRZ 914  
Contact module with single input  
and single output (NAMUR)



LRZ 915  
Contact module with  
3 inputs and 3 outputs



LRZ 917  
Profibus module



LRZ 918  
Pt100/Li bus  
module



LRZ 921  
Ethernet module



LRZ 922  
EtherCAT module  
with M8 connection



LRZ 923  
EtherCAT module  
with RJ45 connection

### LAUDA Proline bridge thermostat / Page 30

### LAUDA Proline clear-view thermostat / Page 32



PB C  
PBD C

576 mm



PB  
PBD

400 mm



PV 24 C  
PVL 24 C

646 mm

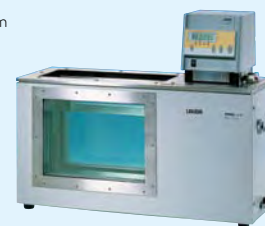

PV 24  
PVL 24

590 mm

# LAUDA Heating thermostats

## Function overview

Operating element	Alpha	ECO S	ECO G	PRO Base	PRO Command Touch	Proline Master	Proline Command
Display	7-Segment	LCD mono	TFT	OLED	TFT	7-Segment	LCD mono
Mode of operation	3-button	3-button softkey	Cursor softkey	Cursor softkey	Multi-touch	4-button	Cursor softkey
Removable control	-	-	-	✓	✓	-	✓
User management	-	-	-	-	✓	-	-
Data logging, export to USB stick	-	-	-	-	✓	-	-
1-point calibration	✓	✓	✓	✓	✓	✓	✓
2-point calibration	-	-	-	✓	✓	-	-
Programmer, programs/segments	-	1 / 20	5 / 150	1 / 20	100 / 5000	-	5 / 150
Programmer, tolerance range function	-	✓	✓	✓	✓	-	✓
Ramp function	-	-	-	-	✓	-	✓
Timer function	-	-	-	-	✓	-	✓
Countdown function	✓	-	-	-	✓	-	✓
Graphic temperature profile display	-	-	✓	-	✓	-	✓
Adjustable bypass	-	-	-	-	-	✓	✓
Level indicator (digital)	-	-	-	✓	✓	✓	✓
Standby timer	-	✓	✓	✓	✓	✓	✓
Low-level alarm	✓	✓	✓	✓	✓	✓	✓
Drain tap	-	✓	✓	✓	✓	✓	✓
Drain screw	✓	-	-	-	-	-	-



# LAUDA Heating thermostats

Technical data according to DIN 12876 standard

Device type	Working temperature range °C	Working temperature range with water cooling °C	Operating temperature range °C	Temperature stability ±K	Safety fittings	Heater power max. kW	Pump type	Pump pressure max. bar	Pump suction max. bar	Pump flow max. pressure L./min	Pump flow max. suction L./min	Pump connection thread mm	Nipples Øe	Bath volume min. L
<b>LAUDA Alpha / Page 24</b>														
A	25...100	20...100	-25...100	0.05	I, NFL	1.5	D	0.2	-	15	-	-	-	-
A 6	25...100	20...100	-25...100	0.05	I, NFL	1.5	D	0.2	-	15	-	-	-	2.5
A 12	25...100	20...100	-25...100	0.05	I, NFL	1.5	D	0.2	-	15	-	-	-	8.0
A 24	25...100	20...100	-25...100	0.05	I, NFL	1.5	D	0.2	-	15	-	-	-	18.0
<b>LAUDA ECO / Page 26</b>														
SILVER	20...200	20...200	-20...200	0.01	III, FL	2.0	V	0.6	-	22	-	-	-	-
ET 6 S	20...100	20...100	-20...100	0.01	III, FL	2.0	V	0.6	-	22	-	-	-	5.0
ET 12 S	20...100	20...100	-20...100	0.01	III, FL	2.0	V	0.6	-	22	-	-	-	9.5
ET 15 S	20...100	20...100	-20...100	0.01	III, FL	2.0	V	0.6	-	22	-	-	13	13.5
ET 20 S	20...100	20...100	-20...100	0.01	III, FL	2.0	V	0.6	-	22	-	-	-	15.0
E 4 S	20...200	20...200	-20...200	0.01	III, FL	2.0	V	0.6	-	22	-	-	13	3.0
E 10 S	20...200	20...200	-20...200	0.01	III, FL	2.0	V	0.6	-	22	-	-	-	7.5
E 20 S	20...200	20...200	-20...200	0.01	III, FL	2.0	V	0.6	-	22	-	-	-	13.0
E 25 S	20...200	20...200	-20...200	0.01	III, FL	2.0	V	0.6	-	22	-	-	-	16.0
E 40 S	20...200	20...200	-20...200	0.01	III, FL	2.0	V	0.6	-	22	-	-	-	32.0
GOLD	20...200	20...200	-20...200	0.01	III, FL	2.6	V	0.6	-	22	-	-	-	-
ET 6 G	20...100	20...100	-20...100	0.01	III, FL	2.6	V	0.6	-	22	-	-	-	5.0
ET 12 G	20...100	20...100	-20...100	0.01	III, FL	2.6	V	0.6	-	22	-	-	-	9.5
ET 15 G	20...100	20...100	-20...100	0.01	III, FL	2.6	V	0.6	-	22	-	M16×1	-	13.5
ET 20 G	20...100	20...100	-20...100	0.01	III, FL	2.6	V	0.6	-	22	-	-	-	15.0
E 4 G	20...200	20...200	-20...200	0.01	III, FL	2.6	V	0.6	-	22	-	M16×1	-	3.0
E 10 G	20...200	20...200	-20...200	0.01	III, FL	2.6	V	0.6	-	22	-	-	-	7.5
E 20 G	20...200	20...200	-20...200	0.01	III, FL	2.6	V	0.6	-	22	-	-	-	13.0
E 25 G	20...200	20...200	-20...200	0.01	III, FL	2.6	V	0.6	-	22	-	-	-	16.0
E 40 G	20...200	20...200	-20...200	0.01	III, FL	2.6	V	0.6	-	22	-	-	-	32.0

Bath volume max. L	Bath opening (W x D) mm	Bath depth mm	Usable depth mm	Height top of bath mm	Dimensions (W x D x H) mm	Weight kg	Power supply V; Hz	Loading max. kW	Cat. No.	Device type
50.0	-	150	100	-	125×150×300	3.5	230 V; 50/60 Hz	1.5	L000618	A
5.5	145×161	150	130	212	181×332×370	6.2	230 V; 50/60 Hz	1.5	L000619	A 6
12.0	235×161	200	180	262	270×332×420	7.5	230 V; 50/60 Hz	1.5	L000620	A 12
25.0	295×374	200	180	262	332×535×420	10.5	230 V; 50/60 Hz	1.5	L000621	A 24
-	-	150	-	-	130×135×325	3.0	230 V; 50/60 Hz	2.1	L001076	SILVER
6.0	130×285	160	140	169	143×433×349	4.1	230 V; 50/60 Hz	2.1	L001096	ET 6 S
12.0	300×175	160	140	208	322×331×389	6.4	230 V; 50/60 Hz	2.1	L001097	ET 12 S
15.0	275×130	310	290	356	428×148×532	6.4	230 V; 50/60 Hz	2.1	L001098	ET 15 S
20.0	300×350	160	140	208	322×506×389	7.6	230 V; 50/60 Hz	2.1	L001099	ET 20 S
3.5	135×105	150	130	196	168×272×376	6.6	230 V; 50/60 Hz	2.1	L001084	E 4 S
11.0	300×190	150	130	196	331×361×376	8.6	230 V; 50/60 Hz	2.1	L001085	E 10 S
19.0	300×365	150	130	196	331×537×376	11.8	230 V; 50/60 Hz	2.1	L001087	E 20 S
25.0	300×365	200	180	246	331×537×426	13.1	230 V; 50/60 Hz	2.1	L001088	E 25 S
40.0	300×613	200	180	248	350×803×428	17.2	230 V; 50/60 Hz	2.1	L001089	E 40 S
-	-	150	-	-	130×135×325	3.4	230 V; 50/60 Hz	2.7	L001077	GOLD
6.0	130×285	160	140	169	143×433×349	4.5	230 V; 50/60 Hz	2.7	L001100	ET 6 G
12.0	300×175	160	140	208	322×331×389	6.8	230 V; 50/60 Hz	2.7	L001101	ET 12 G
15.0	275×130	310	290	356	428×148×532	6.8	230 V; 50/60 Hz	2.7	L001102	ET 15 G
20.0	300×350	160	140	208	322×506×389	8.0	230 V; 50/60 Hz	2.7	L001103	ET 20 G
3.5	135×105	150	130	196	168×272×376	7.0	230 V; 50/60 Hz	2.7	L001090	E 4 G
11.0	300×190	150	130	196	331×361×376	9.0	230 V; 50/60 Hz	2.7	L001091	E 10 G
19.0	300×365	150	130	196	331×537×376	12.2	230 V; 50/60 Hz	2.7	L001093	E 20 G
25.0	300×365	200	180	246	331×537×426	13.5	230 V; 50/60 Hz	2.7	L001094	E 25 G
40.0	300×613	200	180	248	350×803×428	17.6	230 V; 50/60 Hz	2.7	L001095	E 40 G

# LAUDA Heating thermostats

Technical data according to DIN 12876 standard

Device type	Working temperature range °C	Working temperature range with water cooling °C	Operating temperature range °C	Temperature stability ±K	Safety fittings	Heater power max. kW	Pump type	Pump pressure max. bar	Pump suction max. bar	Pump flow max. pressure L./min	Pump flow max. suction L./min	Pump connection thread mm	Nipples Øe	Bath volume min. L
<b>LAUDA PRO / Page 28</b>														
P 10	40...250	20...250	-30...250	0.01	III, FL	3.6	V	-	-	-	-	-	-	5.0
P 20	35...250	20...250	-30...250	0.01	III, FL	3.6	V	-	-	-	-	-	-	11.0
P 30	30...250	20...250	-30...250	0.01	III, FL	3.6	V	-	-	-	-	-	-	15.0
P 10 C	40...250	20...250	-30...250	0.01	III, FL	3.6	V	-	-	-	-	-	-	5.0
P 20 C	35...250	20...250	-30...250	0.01	III, FL	3.6	V	-	-	-	-	-	-	11.0
P 30 C	30...250	20...250	-30...250	0.01	III, FL	3.6	V	-	-	-	-	-	-	15.0
<b>LAUDA Proline Bridge thermostat / Page 30</b>														
PB	30...300	20...300	-30...300	0.01	III, FL	3.6	VF	0.7	0.4	25	23	M16×1	13	-
PBC	30...300	20...300	-30...300	0.01	III, FL	3.6	VF	0.7	0.4	25	23	M16×1	13	-
PBD	30...300	20...300	-30...300	0.01	III, FL	3.6	V	1.1	-	32	-	M16×1	13	-
PBDC	30...300	20...300	-30...300	0.01	III, FL	3.6	V	1.1	-	32	-	M16×1	13	-
<b>LAUDA Proline Clear-view thermostat / Page 32</b>														
PV 15	30...230	20...230	0...230	0.01	III, FL	3.6	V	0.8	-	25	-	M16×1	13	11.0
PV 24	30...230	20...230	0...230	0.01	III, FL	3.6	V	0.8	-	25	-	M16×1	13	19.0
PV 36	30...230	20...230	0...230	0.01	III, FL	3.6	V	0.8	-	25	-	M16×1	13	28.0
PVL 15	30...100	20...100	-60...100	0.01	III, FL	3.6	V	0.8	-	25	-	M16×1	13	11.0
PVL 24	30...100	20...100	-60...100	0.01	III, FL	3.6	V	0.8	-	25	-	M16×1	13	19.0
PBC	30...300	20...300	-30...300	0.01	III, FL	3.6	VF	0.7	0.4	25	23	M16×1	13	-
PBDC	30...300	20...300	-30...300	0.01	III, FL	3.6	V	1.1	-	32	-	M16×1	13	-
PV 15 C	30...230	20...230	0...230	0.01	III, FL	3.6	V	0.8	-	25	-	M16×1	13	11.0
PV 24 C	30...230	20...230	0...230	0.01	III, FL	3.6	V	0.8	-	25	-	M16×1	13	19.0
PV 36 C	30...230	20...230	0...230	0.01	III, FL	3.6	V	0.8	-	25	-	M16×1	13	28.0
PVL 15 C	30...100	20...100	-60...100	0.01	III, FL	3.6	V	0.8	-	25	-	M16×1	13	11.0
PVL 24 C	30...100	20...100	-60...100	0.01	III, FL	3.6	V	0.8	-	25	-	M16×1	13	19.0



Bath volume max. L	Bath opening (W x D) mm	Bath depth mm	Usable depth mm	Height top of bath mm	Dimensions (W x D x H) mm	Weight kg	Power supply V; Hz	Loading max. kW	Cat. No.	Device type
10,0	240×150	200	180	250	310×335×365	13,5	200-230 V; 50/60 Hz	3,7	L000001	P 10
20,0	300×290	200	180	250	350×475×365	17,0	200-230 V; 50/60 Hz	3,7	L000002	P 20
28,5	340×385	200	180	250	400×600×365	23,0	200-230 V; 50/60 Hz	3,7	L000003	P 30
10,0	240×150	200	180	250	310×335×415	13,5	200-230 V; 50/60 Hz	3,7	L000004	P 10 C
20,0	300×290	200	180	250	350×475×415	17,0	200-230 V; 50/60 Hz	3,7	L000005	P 20 C
28,5	340×385	200	180	250	400×600×415	23,0	200-230 V; 50/60 Hz	3,7	L000006	P 30 C
80,0	-	-	-	-	320×185×400	8,0	230 V; 50/60 Hz	3,7	L001542	PB
80,0	-	-	-	-	320×185×576	8,0	230 V; 50/60 Hz	3,7	L001543	PB C
80,0	-	-	-	-	320×185×400	8,0	230 V; 50/60 Hz	3,7	L001544	PBD
80,0	-	-	-	-	320×185×576	8,0	230 V; 50/60 Hz	3,7	L001545	PBD C
15,0	230×135	320	285	390	506×282×590	26,0	230 V; 50/60 Hz	3,7	L001532	PV 15
24,0	405×135	320	285	390	740×282×590	36,0	230 V; 50/60 Hz	3,7	L001533	PV 24
36,0	585×135	320	285	390	1040×282×590	44,0	230 V; 50/60 Hz	3,7	L001534	PV 36
15,0	230×135	320	285	390	506×282×590	28,0	230 V; 50/60 Hz	3,7	L001538	PVL 15
24,0	405×135	320	285	390	740×282×590	39,0	230 V; 50/60 Hz	3,7	L001539	PVL 24
80,0	-	-	-	-	320×185×576	8,0	230 V; 50/60 Hz	3,7	L001543	PB C
80,0	-	-	-	-	320×185×576	8,0	230 V; 50/60 Hz	3,7	L001545	PBD C
15,0	230×135	320	285	390	506×282×646	26,0	230 V; 50/60 Hz	3,7	L001535	PV 15 C
24,0	405×135	320	285	390	740×282×646	36,0	230 V; 50/60 Hz	3,7	L001536	PV 24 C
36,0	585×135	320	285	390	1040×282×646	44,0	230 V; 50/60 Hz	3,7	L001537	PV 36 C
15,0	230×135	320	285	390	506×282×646	28,0	230 V; 50/60 Hz	3,7	L001540	PVL 15 C
24,0	405×135	320	285	390	740×282×646	39,0	230 V; 50/60 Hz	3,7	L001541	PVL 24 C

# LAUDA Heating thermostats

## Power supply variants

Device type	Power supply V; Hz	Heater power max. kW	Loading max. kW	Plug code*	Cat. No.	Device type	Power supply V; Hz	Heater power max. kW	Loading max. kW	Plug code*	Cat. No.
<b>LAUDA Alpha / Page 24</b>											
A	100 V; 50/60 Hz	1.0	1.0	14	L000634	A 12	100 V; 50/60 Hz	1.0	1.0	14	L000636
A	115 V; 60 Hz	1.2	1.2	14	L000630	A 12	115 V; 60 Hz	1.2	1.2	14	L000632
A 6	100 V; 50/60 Hz	1.0	1.0	14	L000635	A 24	100 V; 50/60 Hz	1.0	1.0	14	L000637
A 6	115 V; 60 Hz	1.2	1.2	14	L000631	A 24	115 V; 60 Hz	1.2	1.2	14	L000633
<b>LAUDA ECO / Page 26</b>											
SILVER	100 V; 50/60 Hz	1.0	1.1	14	L001082	E 25 S	100 V; 50/60 Hz	1.0	1.1	14	L001224
SILVER	115 V; 60 Hz	1.3	1.4	14	L001080	E 25 S	115 V; 60 Hz	1.3	1.4	14	L001195
SILVER	220 V; 60 Hz	1.9	2.0	3	L001078	E 25 S	220 V; 60 Hz	1.8	2.1	3	L001175
ET 6 S	100 V; 50/60 Hz	1.0	1.1	14	L001232	E 40 S	100 V; 50/60 Hz	1.0	1.1	14	L001225
ET 6 S	115 V; 60 Hz	1.3	1.4	14	L001203	E 40 S	115 V; 60 Hz	1.3	1.4	14	L001196
ET 6 S	220 V; 60 Hz	1.8	2.0	3	L001183	E 40 S	220 V; 60 Hz	1.8	2.1	3	L001176
ET 12 S	100 V; 50/60 Hz	1.0	1.1	14	L001233	GOLD	100 V; 50/60 Hz	1.0	1.1	14	L001083
ET 12 S	115 V; 60 Hz	1.3	1.4	14	L001204	GOLD	115 V; 60 Hz	1.3	1.4	14	L001081
ET 12 S	220 V; 60 Hz	1.8	2.7	3	L001184	GOLD	220 V; 60 Hz	2.4	2.5	3	L001079
ET 15 S	100 V; 50/60 Hz	1.0	1.1	14	L001234	ET 6 G	100 V; 50/60 Hz	1.0	1.1	14	L001236
ET 15 S	115 V; 60 Hz	1.3	1.4	14	L001205	ET 6 G	115 V; 60 Hz	1.3	1.4	14	L001207
ET 15 S	220 V; 60 Hz	1.8	2.7	3	L001185	ET 6 G	220 V; 60 Hz	2.4	2.5	3	L001187
ET 20 S	100 V; 50/60 Hz	1.0	1.1	14	L001235	ET 12 G	100 V; 50/60 Hz	1.0	1.1	14	L001237
ET 20 S	115 V; 60 Hz	1.3	1.4	14	L001206	ET 12 G	115 V; 60 Hz	1.3	1.4	14	L001208
ET 20 S	220 V; 60 Hz	1.8	2.7	3	L001186	ET 12 G	220 V; 60 Hz	2.4	2.5	3	L001188
E 4 S	100 V; 50/60 Hz	1.0	1.1	14	L001220	ET 15 G	100 V; 50/60 Hz	1.0	1.1	14	L001238
E 4 S	115 V; 60 Hz	1.3	1.4	14	L001191	ET 15 G	115 V; 60 Hz	1.3	1.4	14	L001209
E 4 S	220 V; 60 Hz	1.8	2.1	3	L001171	ET 15 G	220 V; 60 Hz	2.4	2.5	3	L001189
E 10 S	100 V; 50/60 Hz	1.0	1.1	14	L001221	ET 20 G	100 V; 50/60 Hz	1.0	1.1	14	L001239
E 10 S	115 V; 60 Hz	1.3	1.4	14	L001192	ET 20 G	115 V; 60 Hz	1.3	1.4	14	L001210
E 10 S	220 V; 60 Hz	1.8	2.1	3	L001172	ET 20 G	220 V; 60 Hz	2.4	2.5	3	L001190
E 20 S	100 V; 50/60 Hz	1.0	1.1	14	L001223	E 4 G	100 V; 50/60 Hz	1.0	1.1	14	L001226
E 20 S	115 V; 60 Hz	1.3	1.4	14	L001194	E 4 G	115 V; 60 Hz	1.3	1.4	14	L001197
E 20 S	220 V; 60 Hz	1.8	2.1	3	L001174	E 4 G	220 V; 60 Hz	2.4	2.5	3	L001177
E 20 G	100 V; 50/60 Hz	1.0	1.1	14	L001229	E 10 G	100 V; 50/60 Hz	1.0	1.1	14	L001227
E 20 G	115 V; 60 Hz	1.3	1.4	14	L001200	E 10 G	115 V; 60 Hz	1.3	1.4	14	L001198
E 20 G	220 V; 60 Hz	2.4	2.5	3	L001180	E 10 G	220 V; 60 Hz	2.4	2.5	3	L001178

Device type	Power supply V; Hz	Heater power max. kW	Loading max. kW	Plug code*	Cat. No.	Device type	Power supply V; Hz	Heater power max. kW	Loading max. kW	Plug code*	Cat. No.
<b>LAUDA ECO / Page 26</b>											
E 25 G	100 V; 50/60 Hz	1.0	1.1	14	L001230	E 40 G	100 V; 50/60 Hz	1.0	1.1	14	L001231
E 25 G	115 V; 60 Hz	1.3	1.4	14	L001201	E 40 G	115 V; 60 Hz	1.3	1.4	14	L001202
E 25 G	220 V; 60 Hz	2.4	2.5	3	L001181	E 40 G	220 V; 60 Hz	2.4	2.5	3	L001182
<b>LAUDA PRO / Page 28</b>											
P 10	100-120 V; 50/60 Hz	1.9	1.9	4	L000546	P 10 C	100-120 V; 50/60 Hz	1.9	1.9	4	L000550
P 20	100-120 V; 50/60 Hz	1.9	1.9	4	L000547	P 20 C	100-120 V; 50/60 Hz	1.9	1.9	4	L000551
P 30	100-120 V; 50/60 Hz	1.9	1.9	4	L000548	P 30 C	100-120 V; 50/60 Hz	1.9	1.9	4	L000552
<b>LAUDA Proline Bridge thermostat / Page 30</b>											
PB	100 V; 50/60 Hz	1.3	1.5	4	L001590	PBC	100 V; 50/60 Hz	1.3	1.5	4	L001591
PB	115 V; 60 Hz	1.7	1.9	4	L001580	PBC	115 V; 60 Hz	1.7	1.9	4	L001581
<b>LAUDA Proline Clear-view thermostat / Page 32</b>											
PBD	100 V; 50/60 Hz	1.3	1.5	4	L001592	PBD C	100 V; 50/60 Hz	1.3	1.5	4	L001593
PBD	115 V; 60 Hz	1.7	1.9	4	L001582	PBD C	115 V; 60 Hz	1.7	1.9	4	L001583
PV 15	100 V; 50/60 Hz	1.3	1.5	4	L001584	PV 15 C	100 V; 50/60 Hz	1.3	1.5	4	L001585
PV 15	115 V; 60 Hz	1.7	1.9	4	L001574	PV 15 C	115 V; 60 Hz	1.7	1.9	4	L001575
PV 24	200 V; 50/60 Hz	2.7	2.9	3	L001594	PV 24 C	200 V; 50/60 Hz	2.7	2.9	3	L001596
PV 24	208-220 V; 60 Hz	3.3	3.5	3	L001598	PV 24 C	208-220 V; 60 Hz	3.3	3.5	3	L001600
PV 36	200 V; 50/60 Hz	2.7	2.9	3	L001595	PV 36 C	200 V; 50/60 Hz	2.7	2.9	3	L001597
PV 36	208-220 V; 60 Hz	3.3	3.5	3	L001599	PV 36 C	208-220 V; 60 Hz	3.3	3.5	3	L001601
PVL 15	100 V; 50/60 Hz	1.3	1.5	4	L001586	PVL 15 C	100 V; 50/60 Hz	1.3	1.5	4	L001588
PVL 15	115 V; 60 Hz	1.7	1.9	4	L001576	PVL 15 C	115 V; 60 Hz	1.7	1.9	4	L001578
PVL 24	100 V; 50/60 Hz	1.3	1.5	4	L001587	PVL 24 C	100 V; 50/60 Hz	1.3	1.5	4	L001589
PVL 24	115 V; 60 Hz	1.7	1.9	4	L001577	PVL 24 C	115 V; 60 Hz	1.7	1.9	4	L001579

\*All data for the plug codes can be found on page 150

# LAUDA Heating thermostats

## More characteristics

LAUDA Alpha / Page 24

### PUMP CHARACTERISTIC Water

Pressure bar

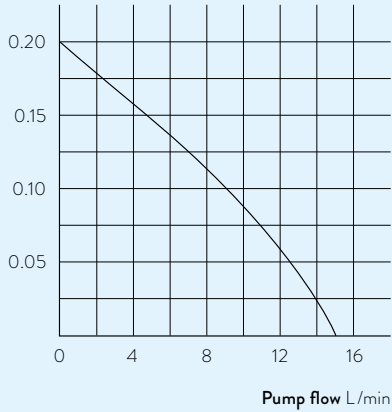

LAUDA ECO / Page 26

### HEATING PERFORMANCE Heat transfer liquid: Therm 240, bath closed

Bath temperature °C

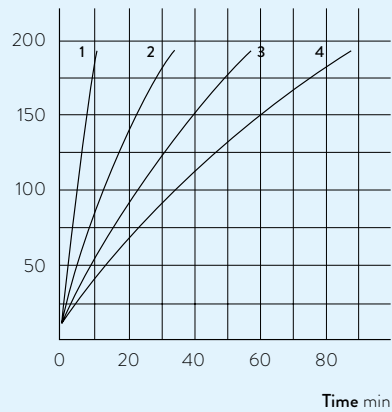

- 1 E 4 S
- 2 E 10 S
- 3 E 20 S
- 4 E 25 S

### HEATING PERFORMANCE Heat transfer liquid: Water, bath closed

Bath temperature °C

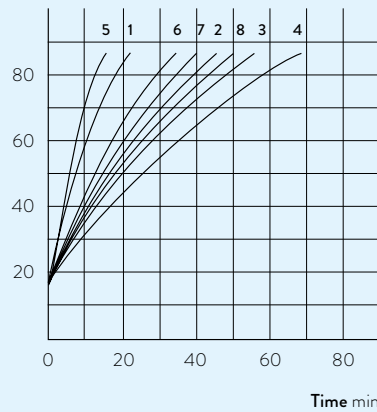

- 1 ET 6 S
- 2 ET 12 S
- 3 ET 15 S
- 4 ET 20 S
- 5 ET 6 G
- 6 ET 12 G
- 7 ET 15 G
- 8 ET 20 G

### PUMP CHARACTERISTIC Water

Pressure bar

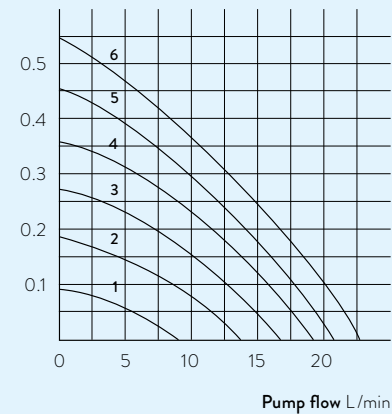

- 1 Step 1
- 2 Step 2
- 3 Step 3
- 4 Step 4
- 5 Step 5
- 6 Step 6

**PUMP CHARACTERISTIC** for PB and PBC, Water

Pressure bar

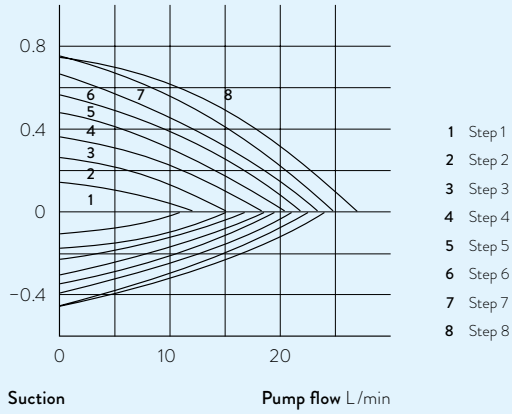

Suction

Pump flow L/min

**PUMP CHARACTERISTIC** for PB and PBC, Water

Pressure bar

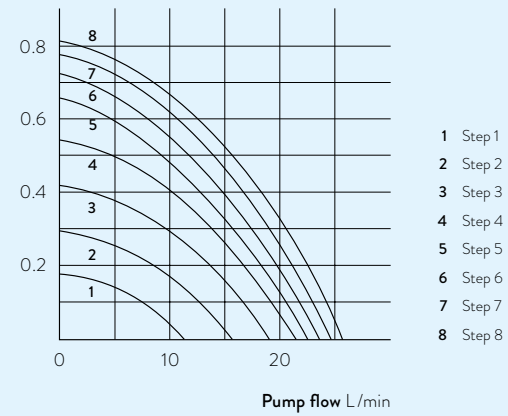

Pump flow L/min

# LAUDA

## COOLING THERMOSTATS

### Specific application examples

---

- Sample preparation in chemistry and pharmacy
- Functional testing of electronic components
- Test of slide bearings
- Beer forcing test
- Valve testing
- Stress test
- Notch bending test
- Expansion testing
- Brookfield test
- Semi-conductor coating



Cooling thermostats

Circulation and process thermostats

Circulation chillers

Calibration thermostats

Add. equipment

Heat transfer liquids

Accessories

# LAUDA Alpha

Affordable cooling thermostats for maintaining temperatures from  $-25$  to  $100$  °C in the lab



## The cost-efficient choice for high-quality LAUDA thermostats

LAUDA Alpha offers reliable technology for temperature ranges from  $-25$  to  $100$  °C. This line of devices is suitable for internal and external temperature control thermostating with non-flammable liquids (water and water/glycol). The thermostats are the perfect solution for most basic temperature control applications in the lab. Optimized down to the most essential functions, this affordable product line will win you over with its reliability and user-friendliness.



Cost savings through automatic compressor control: Cooling capacity is only provided when it is needed



Easy cleaning of the cooling air inlet enabled by simple removal of front cover without tools

## COOLING PERFORMANCE Heat transfer liquid: Ethanol, bath closed

Bath temperature °C

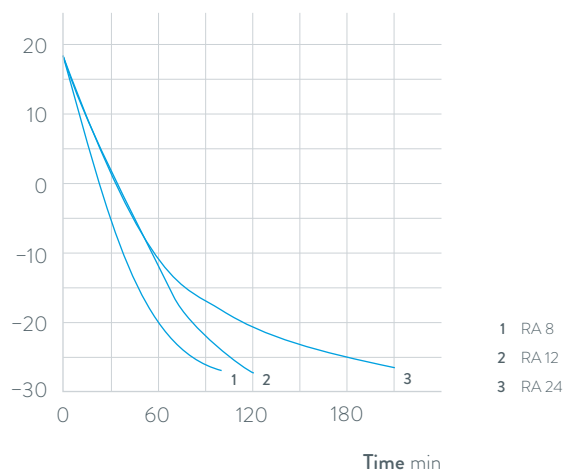

## Important functions

- Stainless steel bath vessels
- Drain connection at the rear

## Included accessories

Pump circulation set, bath cover, pump link for pump connections

## Further accessories

Racks, tubing

All technical data and power supply variants can be found in the ›Technical data‹ section.

More at [www.lauda.de/1736](http://www.lauda.de/1736)





### LAUDA Alpha

The cooling thermostats RA 8, RA 12 and RA 24, including standard-issue bath covers and pump connections, facilitate cooling across the entire temperature range from  $-25$  to  $100$  °C. Automatic compressor control extends the service life of the compressor and offers savings on operation costs.



# LAUDA ECO

From  $-50$  to  $200$  °C: Cooling thermostats for economic temperature control in the lab



## Impressive range of capabilities coupled with easy operation

The ECO thermostats are available in standard Silver (LCD) or Gold (color TFT display) models equipped with a mini USB interface. The circulation pump can be adjusted to six levels. The comprehensive model portfolio offers devices with cooling capacities of 180 to 700 watts and minimum temperatures of  $-15$  to  $-50$  °C. The devices of the LAUDA ECO series with the highest performance work with an energy-saving LAUDA SmartCool system which automatically adjusts the cooling capacity to the required operating condition.



Plain text menu guidance on a monochrome LCD (Silver) or color TFT display (Gold) for easy and intuitive operation



Standard pump connections for temperature control of external applications

## COOLING PERFORMANCE Heat transfer liquid: Ethanol, bath closed

Bath temperature °C

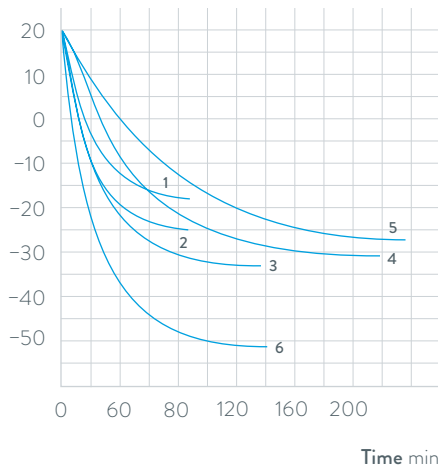

- 1 RE 415 G
- 2 RE 420 G
- 3 RE 630 G
- 4 RE 1225 G
- 5 RE 2025 G
- 6 RE 1050 G

## Important functions

- Integrated programmer for automating temperature profiles
- Adjustment of flow rate switch for internal/external circulation, can be actuated from exterior during operation
- USB interface as standard

## Included accessories

Bath cover, pump connections, closing plugs

## Further accessories

Tubing, interface modules

All technical data and power supply variants can be found in the ›Technical data‹ section.

More at [www.lauda.de/1738](http://www.lauda.de/1738)



## LAUDA ECO

The cooling thermostats come with a bath cover and pump connections as standard. A drain tap on the back side of the device makes changing the heat transfer liquid easy and safe.



# LAUDA PRO

## Cooling bath thermostats for professional temperature control from $-100$ to $200$ °C



### Flexible operation, outstanding performance

With LAUDA PRO, customers gain access to a cutting-edge product line with an outstanding overall concept. There are two operating units available: Base or Command Touch. These can be removed from the thermostat for very high levels of flexibility. On the one hand, this permits remote control of the devices and on the other hand, this considerably reduces the height of the devices. In addition, they are also equipped with a hybrid cooling system as standard. This enables additional cooling of the refrigerating machine with water.



Low device height and  $360^\circ$  accessibility of the bath thanks to detachable remote control

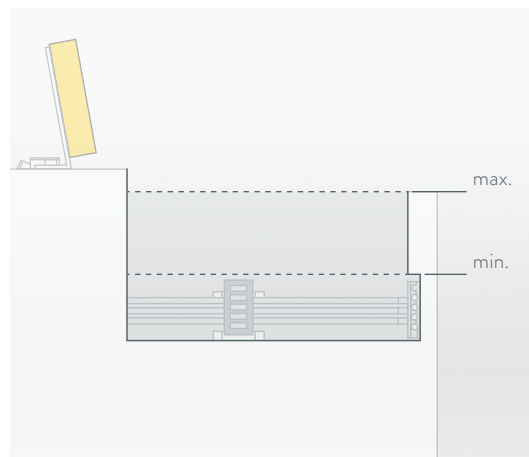

Full functionality of the bath with low minimum fill height

### COOLING PERFORMANCE Heat transfer liquid: Ethanol, bath closed

Bath temperature °C

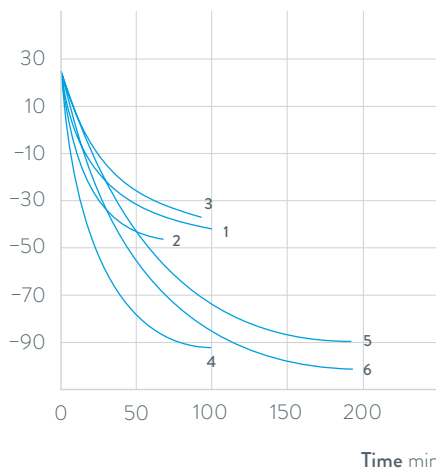

- 1 RP 2040 C
- 2 RP 2045 C
- 3 RP 3035 C
- 4 RP 1090 C
- 5 RP 2090 C
- 6 RP 10100 C

### Important functions

- Internal LAUDA Vario Pump with 8 selectable output levels
- Hybrid cooling of the refrigerating machine permits cooling using ambient air or, in addition, using cooling water
- Standard bath edge heating on all types prevents the formation of ice on the surface of the bath cover

### Included accessories

Bath cover, tubing nipples with screw caps for the cooling coil

### Further accessories

External pump, interface modules

All technical data and power supply variants can be found in the ›Technical data‹ section.

More at [www.lauda.de/1740](http://www.lauda.de/1740)



## LAUDA PRO

The PRO cooling bath thermostats for internal bath applications offer a working temperature range from  $-100$  to  $200$  °C. A multi-stage adjustable pump ensures excellent homogeneity of the bath. With their bath sizes from 10 to 30 liters and cooling capacity from 0.4 to 1.5 kW, the thermostats are suitable for a wide range of applications.



# LAUDA Proline Kryomats

High-performance cooling thermostats from  $-90$  to  $200$  °C for use in process technology and material testing

$-90$  °C

$200$  °C

## High cooling performance and compact design

The Proline Kryomats are cooling thermostats that feature the latest technology with high efficiency and an excellent price-performance ratio. The pressure pump is optimized for internal circulation and can be set to four levels – the standard-issue LAUDA Command remote control also makes it especially user-friendly. Furthermore, integrated bath edge and bath bridge heating prevent the formation of condensation caused by air humidity at low temperatures.



Optimal circulation and temperature distribution throughout the entire bath thanks to an adjustable pump nozzle



Spacious baths and large bath openings – ideal for bulky test specimens and effective throughput

## COOLING PERFORMANCE Heat transfer liquid: Ethanol, bath closed

Bath temperature °C

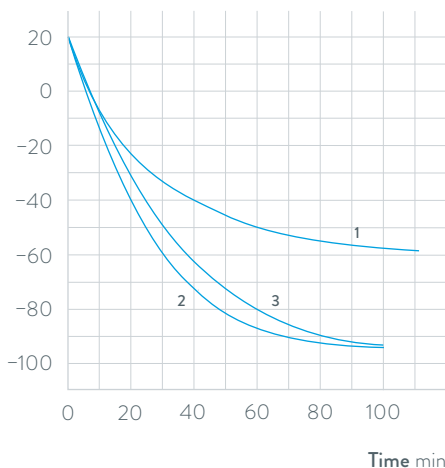

- 1 RP 4050 C
- 2 RP 3090 C
- 3 RP 4090 C

## Important functions

- Removable Command operating unit with high-resolution, graphic LCD screen and individually selectable display functions
- Programmer with 150 temperature/time segments, can be divided into 5 programs
- Pump connections on side and rear, integrated bypass

## Included accessories

Bath cover, tubing nipples

## Further accessories

Inset baskets, interface modules

All technical data and power supply variants can be found in the ›Technical data‹ section.

More at [www.lauda.de/1742](http://www.lauda.de/1742)



### LAUDA Proline Kryomats

The air and water-cooled versions of the Proline Kryomats are available with large bath openings and volumes of 30 and 40 liters.



# LAUDA Cooling thermostats

## Device type overview

### LAUDA Alpha / Page 48

---



RA 8



RA 12



RA 24

### LAUDA ECO / Page 50

---



RE 415 G



RE 420 G



RE 630 G



RE 1050 G



RE 1225 G



RE 2025 G

### LAUDA PRO / Page 52

---



RP 2040 C  
RP 2045 C



RP 3035 C



RP 1090 C



RP 2090 C  
RP 10100 C

### LAUDA Proline Kryomats / Page 54

---



RP 3090 CW  
RP 4050 CW  
RP 4090 CW



RP 3090 C  
RP 4050 C  
RP 4090 C



# LAUDA Cooling thermostats

## Interfaces

	Pt 100	USB	Ethernet	RS 232 / 485	Analog	Namur contact	Sub-D contact	Profibus	EtherCat M8	EtherCat RJ 45	Number of module slots, large	Number of module slots, small
LAUDA Alpha / Page 48	-	-	-	-	-	-	-	-	-	-	-	-
LAUDA ECO / Page 50	Z	S	Z	Z	Z	Z	Z	Z	Z	Z	1	1
LAUDA PRO / Page 52	S	S	S	Z	Z	Z	Z	Z	Z	Z	1	-
LAUDA Proline Kryomats / Page 54	S	-	Z	S	Z	Z	Z	Z	Z	Z	2	-

S = Series standard

Z = Available as an accessory



LRZ 912  
Analog module



LRZ 913  
RS 232/485  
interface



LRZ 914  
Contact module with single input  
and single output (NAMUR)



LRZ 915  
Contact module with  
3 inputs and 3 outputs



LRZ 917  
Profibus module



LRZ 918  
Pt100/Li bus  
module



LRZ 921  
Ethernet module



LRZ 922  
EtherCAT module  
with M8 connection



LRZ 923  
EtherCAT module  
with RJ45 connection

# LAUDA Cooling thermostats

## Function overview

Operating element	Alpha	ECO S	ECO G	PRO Base	PRO Command Touch	Proline Kryomats
Display	7-Segment	LCD mono	TFT	OLED	TFT	LCD mono
Mode of operation	3-button	3-button softkey	Cursor softkey	Cursor softkey	Multi-touch	Cursor softkey
Removable control	-	-	-	√	√	√
User management	-	-	-	-	√	-
Data logging, export to USB stick	-	-	-	-	√	-
1-point calibration	√	√	√	√	√	√
2-point calibration	-	-	-	√	√	-
Programmer, programs/segments	-	1 / 20	5 / 150	1 / 20	100 / 5000	5 / 150
Programmer, tolerance range function	-	√	√	√	√	√
Ramp function	-	-	-	-	√	√
Timer function	-	-	-	-	√	√
Countdown function	√	-	-	-	√	√
Graphic temperature profile display	-	-	√	-	√	√
Adjustable bypass	-	-	-	-	-	√
Level indicator (digital)	-	-	-	√	√	√
Standby timer	-	√	√	√	√	√
Low-level alarm	√	√	√	√	√	√
Drain tap	-	√	√	√	√	√
Drain screw	√	-	-	-	-	-



# LAUDA Cooling thermostats

Technical data according to DIN 12876 standard

Device type	Working temperature range °C	Temperature stability ±K	Safety fittings	Heater power max. kW	Cooling output kW														Pump type	Pump pressure max. bar
					20 °C	10 °C	0 °C	-10 °C	-20 °C	-25 °C	-30 °C	-40 °C	-50 °C	-60 °C	-70 °C	-80 °C	-90 °C	-100 °C		
<b>LAUDA Alpha / Page 48</b>																				
RA 8	-25 ... 100	0.05	I, NFL	1.5	0.23	-	0.16	-	0.08	-	-	-	-	-	-	-	-	D	0.2	
RA 12	-25 ... 100	0.05	I, NFL	1.5	0.33	-	0.26	-	0.08	-	-	-	-	-	-	-	-	D	0.2	
RA 24	-25 ... 100	0.05	I, NFL	1.5	0.43	-	0.33	-	0.08	-	-	-	-	-	-	-	-	D	0.2	
<b>LAUDA ECO / Page 50</b>																				
RE 415 S	-15 ... 200	0.02	III, FL	2.0	0.18 <sup>1</sup>	-	0.12 <sup>1</sup>	-	-	-	-	-	-	-	-	-	-	V	0.6	
RE 420 S	-20 ... 200	0.02	III, FL	2.0	0.20 <sup>1</sup>	-	0.15 <sup>1</sup>	-	0.03 <sup>1</sup>	-	-	-	-	-	-	-	-	V	0.6	
RE 630 S	-30 ... 200	0.02	III, FL	2.0	0.30 <sup>1</sup>	-	0.24 <sup>1</sup>	-	0.10 <sup>1</sup>	-	0.02 <sup>1</sup>	-	-	-	-	-	-	V	0.6	
RE 1050 S	-50 ... 200	0.02	III, FL	2.0	0.70 <sup>1</sup>	-	0.60 <sup>1</sup>	-	0.35 <sup>1</sup>	-	0.19 <sup>1</sup>	0.10 <sup>1</sup>	0.02 <sup>1</sup>	-	-	-	-	V	0.6	
RE 1225 S	-25 ... 200	0.02	III, FL	2.0	0.30 <sup>1</sup>	-	0.24 <sup>1</sup>	-	0.09 <sup>1</sup>	0.04 <sup>1</sup>	-	-	-	-	-	-	-	V	0.6	
RE 2025 S	-25 ... 200	0.02	III, FL	2.0	0.30 <sup>1</sup>	-	0.23 <sup>1</sup>	-	0.06 <sup>1</sup>	0.03 <sup>1</sup>	-	-	-	-	-	-	-	V	0.6	
RE 415 G	-15 ... 200	0.02	III, FL	2.6	0.18 <sup>1</sup>	-	0.12 <sup>1</sup>	-	-	-	-	-	-	-	-	-	-	V	0.6	
RE 420 G	-20 ... 200	0.02	III, FL	2.6	0.20 <sup>1</sup>	-	0.15 <sup>1</sup>	-	0.03 <sup>1</sup>	-	-	-	-	-	-	-	-	V	0.6	
RE 630 G	-30 ... 200	0.02	III, FL	2.6	0.30 <sup>1</sup>	-	0.24 <sup>1</sup>	-	0.10 <sup>1</sup>	-	0.02 <sup>1</sup>	-	-	-	-	-	-	V	0.6	
RE 1050 G	-50 ... 200	0.02	III, FL	2.6	0.70 <sup>1</sup>	-	0.60 <sup>1</sup>	-	0.35 <sup>1</sup>	-	0.19 <sup>1</sup>	0.10 <sup>1</sup>	0.02 <sup>1</sup>	-	-	-	-	V	0.6	
RE 1225 G	-25 ... 200	0.02	III, FL	2.6	0.30 <sup>1</sup>	-	0.24 <sup>1</sup>	-	0.09 <sup>1</sup>	0.04 <sup>1</sup>	-	-	-	-	-	-	-	V	0.6	
RE 2025 G	-25 ... 200	0.02	III, FL	2.6	0.30 <sup>1</sup>	-	0.23 <sup>1</sup>	-	0.06 <sup>1</sup>	0.03 <sup>1</sup>	-	-	-	-	-	-	-	V	0.6	

<sup>1</sup>Pump output step 2

Pump suction max. bar	Pump flow max. pressure L/min	Pump flow max. suction L/min	Pump connection thread mm	Nipples $\varnothing_e$	Bath volume max. L	Bath opening (W x D) mm	Bath depth mm	Usable depth mm	Height top of bath mm	Dimensions (W x D x H) mm	Weight kg	Power supply V; Hz	Loading max. kW	Cat. No.	Device type
-	15	-	N/A	13	7.5	165x177	160	140	450	235x500x605	31.0	230 V; 50 Hz	1.8	L000638	RA 8
-	15	-	N/A	13	14.5	300x203	160	140	450	365x500x605	37.0	230 V; 50 Hz	1.8	L000639	RA 12
-	15	-	N/A	13	22.0	350x277	160	140	450	415x605x605	43.0	230 V; 50 Hz	1.8	L000640	RA 24
-	22	-	N/A	13	4.0	130x105	160	140	365	180x350x546	19.6	230 V; 50 Hz	2.2	L001249	RE 415 S
-	22	-	N/A	13	4.0	130x105	160	140	374	180x396x555	21.6	230 V; 50 Hz	2.2	L001333	RE 420 S
-	22	-	N/A	13	5.7	150x130	160	140	400	200x430x581	27.2	230 V; 50 Hz	2.3	L001335	RE 630 S
-	22	-	N/A	13	10.0	200x200	160	140	443	280x440x624	34.6	230 V; 50 Hz	2.5	L001336	RE 1050 S
-	22	-	N/A	13	12.0	200x200	200	180	443	250x435x624	30.0	230 V; 50 Hz	2.3	L001337	RE 1225 S
-	22	-	N/A	13	20.0	300x350	160	140	443	350x570x624	37.0	230 V; 50 Hz	2.3	L001338	RE 2025 S
-	22	-	M16x1	13	4.0	130x105	160	140	365	180x350x546	20.0	230 V; 50 Hz	2.8	L001256	RE 415 G
-	22	-	M16x1	13	4.0	130x105	160	140	374	180x396x555	22.0	230 V; 50 Hz	2.8	L001339	RE 420 G
-	22	-	M16x1	13	5.7	150x130	160	140	400	200x430x581	27.6	230 V; 50 Hz	2.9	L001341	RE 630 G
-	22	-	M16x1	13	10.0	200x200	160	140	443	280x440x624	35.0	230 V; 50 Hz	3.1	L001342	RE 1050 G
-	22	-	M16x1	13	12.0	200x200	200	180	443	250x435x624	30.4	230 V; 50 Hz	2.9	L001343	RE 1225 G
-	22	-	M16x1	13	20.0	300x350	160	140	443	350x570x624	37.4	230 V; 50 Hz	2.9	L001344	RE 2025 G

# LAUDA Cooling thermostats

Technical data according to DIN 12876 standard

Device type	Working temperature range °C	Temperature stability ±K	Safety fittings	Heater power max. kW	Cooling output kW													Pump type	Pump pressure max. bar	
					20 °C	10 °C	0 °C	-10 °C	-20 °C	-25 °C	-30 °C	-40 °C	-50 °C	-60 °C	-70 °C	-80 °C	-90 °C			-100 °C
<b>LAUDA PRO / Page 52</b>																				
RP 2040	-40 ... 200	0.01	III, FL	3.6	0.80 <sup>3</sup>	0.80 <sup>3</sup>	0.80 <sup>3</sup>	0.60 <sup>3</sup>	0.40 <sup>2</sup>	-	0.19 <sup>2</sup>	0.06 <sup>2</sup>	-	-	-	-	-	V	-	
RP 2045	-45 ... 200	0.01	III, FL	3.6	1.50 <sup>3</sup>	1.43 <sup>3</sup>	1.17 <sup>3</sup>	0.84 <sup>3</sup>	0.52 <sup>2</sup>	-	0.28 <sup>2</sup>	0.13 <sup>2</sup>	-	-	-	-	-	V	-	
RP 3035	-35 ... 200	0.01	III, FL	3.6	0.80 <sup>3</sup>	0.80 <sup>3</sup>	0.80 <sup>3</sup>	0.58 <sup>3</sup>	0.35 <sup>2</sup>	-	0.16 <sup>2</sup>	-	-	-	-	-	-	V	-	
RP 1090	-90 ... 200	0.01	III, FL	3.6	0.80 <sup>3</sup>	0.75 <sup>3</sup>	0.72 <sup>3</sup>	0.69 <sup>3</sup>	0.66 <sup>2</sup>	-	0.63 <sup>2</sup>	0.60 <sup>2</sup>	0.54 <sup>2</sup>	0.37 <sup>2</sup>	0.24 <sup>2</sup>	0.11 <sup>2</sup>	0.02 <sup>2</sup>	V	-	
RP 2090	-90 ... 200	0.01	III, FL	3.6	0.80 <sup>3</sup>	0.71 <sup>3</sup>	0.68 <sup>3</sup>	0.65 <sup>3</sup>	0.62 <sup>2</sup>	-	0.61 <sup>2</sup>	0.58 <sup>2</sup>	0.52 <sup>2</sup>	0.34 <sup>2</sup>	0.18 <sup>2</sup>	0.07 <sup>2</sup>	0.01 <sup>2</sup>	V	-	
RP 10100	-100 ... 200	0.01	III, FL	3.6	0.40 <sup>3</sup>	0.40 <sup>3</sup>	0.40 <sup>3</sup>	0.40 <sup>3</sup>	0.40 <sup>2</sup>	-	0.39 <sup>2</sup>	0.37 <sup>2</sup>	0.35 <sup>2</sup>	0.32 <sup>2</sup>	0.25 <sup>2</sup>	0.17 <sup>2</sup>	0.06 <sup>2</sup>	0.01 <sup>2</sup>	V	-
RP 2040 C	-40 ... 200	0.01	III, FL	3.6	0.80 <sup>3</sup>	0.80 <sup>3</sup>	0.80 <sup>3</sup>	0.60 <sup>3</sup>	0.40 <sup>2</sup>	-	0.19 <sup>2</sup>	0.06 <sup>2</sup>	-	-	-	-	-	V	-	
RP 2045 C	-45 ... 200	0.01	III, FL	3.6	1.50 <sup>3</sup>	1.43 <sup>3</sup>	1.17 <sup>3</sup>	0.84 <sup>3</sup>	0.52 <sup>2</sup>	-	0.28 <sup>2</sup>	0.13 <sup>2</sup>	-	-	-	-	-	V	-	
RP 3035 C	-35 ... 200	0.01	III, FL	3.6	0.80 <sup>3</sup>	0.80 <sup>3</sup>	0.80 <sup>3</sup>	0.58 <sup>3</sup>	0.35 <sup>2</sup>	-	0.16 <sup>2</sup>	-	-	-	-	-	-	V	-	
RP 1090 C	-90 ... 200	0.01	III, FL	3.6	0.80 <sup>3</sup>	0.75 <sup>3</sup>	0.72 <sup>3</sup>	0.69 <sup>3</sup>	0.66 <sup>2</sup>	-	0.63 <sup>2</sup>	0.60 <sup>2</sup>	0.54 <sup>2</sup>	0.37 <sup>2</sup>	0.24 <sup>2</sup>	0.11 <sup>2</sup>	0.02 <sup>2</sup>	V	-	
RP 2090 C	-90 ... 200	0.01	III, FL	3.6	0.80 <sup>3</sup>	0.71 <sup>3</sup>	0.68 <sup>3</sup>	0.65 <sup>3</sup>	0.62 <sup>2</sup>	-	0.61 <sup>2</sup>	0.58 <sup>2</sup>	0.52 <sup>2</sup>	0.34 <sup>2</sup>	0.18 <sup>2</sup>	0.07 <sup>2</sup>	0.01 <sup>2</sup>	V	-	
RP 10100 C	-100 ... 200	0.01	III, FL	3.6	0.40 <sup>3</sup>	0.40 <sup>3</sup>	0.40 <sup>3</sup>	0.40 <sup>3</sup>	0.40 <sup>2</sup>	-	0.39 <sup>2</sup>	0.37 <sup>2</sup>	0.35 <sup>2</sup>	0.32 <sup>2</sup>	0.25 <sup>2</sup>	0.17 <sup>2</sup>	0.06 <sup>2</sup>	0.01 <sup>2</sup>	V	-
<b>LAUDA Proline Kryomats / Page 54</b>																				
RP 4050 C	-50 ... 200	0.01	III, FL	3.5	5.00 <sup>1</sup>	-	3.00 <sup>1</sup>	-	1.60 <sup>1</sup>	-	1.00 <sup>1</sup>	0.50 <sup>1</sup>	0.25 <sup>1</sup>	-	-	-	-	V	0.5	
RP 4050 CW	-50 ... 200	0.01	III, FL	3.5	6.00 <sup>1</sup>	-	3.50 <sup>1</sup>	-	1.80 <sup>1</sup>	-	1.10 <sup>1</sup>	0.60 <sup>1</sup>	0.25 <sup>1</sup>	-	-	-	-	V	0.5	
RP 3090 C	-90 ... 200	0.01	III, FL	3.5	3.00 <sup>1</sup>	-	2.90 <sup>1</sup>	-	2.50 <sup>1</sup>	-	2.30 <sup>1</sup>	2.00 <sup>1</sup>	1.60 <sup>1</sup>	1.30 <sup>1</sup>	0.80 <sup>1</sup>	0.50 <sup>1</sup>	0.15 <sup>1</sup>	V	0.5	
RP 3090 CW	-90 ... 200	0.01	III, FL	3.5	4.00 <sup>1</sup>	-	3.70 <sup>1</sup>	-	3.10 <sup>1</sup>	-	2.70 <sup>1</sup>	2.30 <sup>1</sup>	1.80 <sup>1</sup>	1.40 <sup>1</sup>	-	0.50 <sup>1</sup>	0.15 <sup>1</sup>	V	0.5	
RP 4090 C	-90 ... 200	0.01	III, FL	3.5	3.00 <sup>1</sup>	-	2.90 <sup>1</sup>	-	2.50 <sup>1</sup>	-	2.30 <sup>1</sup>	2.00 <sup>1</sup>	1.60 <sup>1</sup>	1.30 <sup>1</sup>	0.80 <sup>1</sup>	0.50 <sup>1</sup>	0.15 <sup>1</sup>	V	0.5	
RP 4090 CW	-90 ... 200	0.01	III, FL	3.5	4.00 <sup>1</sup>	-	3.70 <sup>1</sup>	-	3.10 <sup>1</sup>	-	2.70 <sup>1</sup>	2.30 <sup>1</sup>	1.80 <sup>1</sup>	1.40 <sup>1</sup>	-	0.50 <sup>1</sup>	0.15 <sup>1</sup>	V	0.5	

<sup>1</sup>Pump output step 2 <sup>2</sup>Pump output step 4 <sup>3</sup>Pump output step 8 All device types with mark >W< are water-cooled

Pump suction max. bar	Pump flow max. pressure L/min	Pump flow max. suction L/min	Pump connection thread mm	Nipples Øe	Bath volume max. L	Bath opening (W x D) mm	Bath depth mm	Usable depth mm	Height top of bath mm	Dimensions (W x D x H) mm	Weight kg	Power supply V; Hz	Loading max. kW	Cat. No.	Device type
-	-	-	-	-	21.0	300×290	200	180	568	400×565×680	54.0	230 V; 50 Hz	3.7	L000007	RP 2040
-	-	-	-	-	21.0	300×290	200	180	568	400×565×680	59.0	230 V; 50 Hz	3.7	L000008	RP 2045
-	-	-	-	-	29.5	340×375	200	180	568	440×600×680	57.0	230 V; 50 Hz	3.7	L000009	RP 3035
-	-	-	-	-	10.5	240×150	200	180	618	440×600×730	83.0	230 V; 50 Hz	3.7	L000010	RP 1090
-	-	-	-	-	21.0	300×290	200	180	618	500×600×730	89.0	230 V; 50 Hz	3.7	L000011	RP 2090
-	-	-	-	-	10.5	240×150	200	180	618	500×600×730	83.0	230 V; 50 Hz	3.7	L000012	RP 10100
-	-	-	-	-	21.0	300×290	200	180	568	400×565×730	54.0	230 V; 50 Hz	3.7	L000013	RP 2040 C
-	-	-	-	-	21.0	300×290	200	180	568	400×565×730	59.0	230 V; 50 Hz	3.7	L000014	RP 2045 C
-	-	-	-	-	29.5	340×375	200	180	568	440×600×730	57.0	230 V; 50 Hz	3.7	L000015	RP 3035 C
-	-	-	-	-	10.5	240×150	200	180	618	440×600×780	83.0	230 V; 50 Hz	3.7	L000016	RP 1090 C
-	-	-	-	-	21.0	300×290	200	180	618	500×600×780	89.0	230 V; 50 Hz	3.7	L000017	RP 2090 C
-	-	-	-	-	10.5	240×150	200	180	618	500×600×780	83.0	230 V; 50 Hz	3.7	L000018	RP 10100 C
-	19	-	M16×1	13	44.0	350×350	250	230	905	600×700×1216	130.0	400 V; 3/N/PE; 50 Hz	5.0	L001653	RP 4050 C
-	19	-	M16×1	13	44.0	350×350	250	230	905	600×700×1216	130.0	400 V; 3/N/PE; 50 Hz	5.0	L001657	RP 4050 CW
-	19	-	M16×1	13	31.0	350×200	250	230	905	600×700×1216	155.0	400 V; 3/N/PE; 50 Hz	7.0	L001654	RP 3090 C
-	19	-	M16×1	13	31.0	350×200	250	230	905	600×700×1216	155.0	400 V; 3/N/PE; 50 Hz	7.0	L001658	RP 3090 CW
-	19	-	M16×1	13	44.0	350×350	250	230	905	600×700×1216	155.0	400 V; 3/N/PE; 50 Hz	7.0	L001655	RP 4090 C
-	19	-	M16×1	13	44.0	350×350	250	230	905	600×700×1216	155.0	400 V; 3/N/PE; 50 Hz	7.0	L001659	RP 4090 CW

# LAUDA Cooling thermostats

## Power supply variants

Device type	Power supply V; Hz	Heater power max. kW	Loading max. kW	Plug code*	Cat. No.	Device type	Power supply V; Hz	Heater power max. kW	Loading max. kW	Plug code*	Cat. No.
<b>LAUDA Alpha / Page 48</b>											
RA 8	100 V; 50/60 Hz	1.0	1.3	14	L000653	RA 12	220 V; 60 Hz	1.4	1.8	17	L000648
RA 8	115 V; 60 Hz	1.2	1.5	14	L000650	RA 24	100 V; 50/60 Hz	1.0	1.3	14	L000655
RA 8	220 V; 60 Hz	1.4	1.8	17	L000647	RA 24	115 V; 60 Hz	1.2	1.5	14	L000652
RA 12	100 V; 50/60 Hz	1.0	1.3	14	L000654	RA 24	220 V; 60 Hz	1.4	1.8	17	L000649
RA 12	115 V; 60 Hz	1.2	1.5	14	L000651						
<b>LAUDA ECO / Page 50</b>											
RE 415 S	100 V; 50/60 Hz	1.2	1.2	14	L001461	RE 1050 S	100 V; 50/60 Hz	1.0	1.5	14	L001465
RE 415 S	115 V; 60 Hz	1.3	1.4	14	L001433	RE 1050 S	115 V; 60 Hz	1.3	1.4	14	L001437
RE 415 S	220 V; 60 Hz	1.8	2.1	2	L002073	RE 1050 S	220 V; 60 Hz	1.8	2.4	2	L002077
RE 415 S	220 V; 60 Hz	1.8	2.1	3	L001405	RE 1050 S	220 V; 60 Hz	1.8	2.4	3	L001409
RE 415 G	100 V; 50/60 Hz	1.0	1.2	14	L001468	RE 1050 G	100 V; 50/60 Hz	1.0	1.5	14	L001472
RE 415 G	115 V; 60 Hz	1.3	1.4	14	L001440	RE 1050 G	115 V; 60 Hz	1.3	1.4	14	L001444
RE 415 G	220 V; 60 Hz	2.4	2.6	3	L001412	RE 1050 G	220 V; 60 Hz	2.4	2.9	3	L001416
RE 415 G	220 V; 60 Hz	2.4	2.6	2	L002080	RE 1225 S	100 V; 50/60 Hz	1.0	1.3	14	L001466
RE 420 S	100 V; 50/60 Hz	1.0	1.2	14	L001462	RE 1225 S	115 V; 60 Hz	1.3	1.4	14	L001438
RE 420 S	115 V; 60 Hz	1.3	1.4	14	L001434	RE 1225 S	220 V; 60 Hz	1.8	2.1	3	L001410
RE 420 S	220 V; 60 Hz	1.8	2.1	3	L001406	RE 1225 S	220 V; 60 Hz	1.8	2.1	2	L002078
RE 420 S	220 V; 60 Hz	1.8	2.1	2	L002074	RE 1225 G	100 V; 50/60 Hz	1.0	1.3	14	L001473
RE 420 G	100 V; 50/60 Hz	1.0	1.2	14	L001469	RE 1225 G	115 V; 60 Hz	1.3	1.4	14	L001445
RE 420 G	115 V; 60 Hz	1.3	1.4	14	L001441	RE 1225 G	220 V; 60 Hz	2.4	2.7	3	L001417
RE 420 G	220 V; 60 Hz	2.4	2.6	3	L001413	RE 2025 S	100 V; 50/60 Hz	1.0	1.3	14	L001467
RE 630 S	100 V; 50/60 Hz	1.0	1.3	14	L001464	RE 2025 S	115 V; 60 Hz	1.3	1.4	14	L001439
RE 630 S	115 V; 60 Hz	1.3	1.4	14	L001436	RE 2025 S	220 V; 60 Hz	1.8	2.1	3	L001411
RE 630 S	220 V; 60 Hz	1.8	2.1	3	L001408	RE 2025 G	100 V; 50/60 Hz	1.0	1.3	14	L001474
RE 630 S	220 V; 60 Hz	1.8	2.1	2	L002076	RE 2025 G	115 V; 60 Hz	1.3	1.4	14	L001446
RE 630 G	100 V; 50/60 Hz	1.0	1.3	14	L001471	RE 2025 G	220 V; 60 Hz	2.4	2.7	3	L001418
RE 630 G	115 V; 60 Hz	1.3	1.4	14	L001443						
RE 630 G	220 V; 60 Hz	2.4	2.7	3	L001415						
RE 630 G	220 V; 60 Hz	2.4	2.7	2	L002083						

\*All data for the plug codes can be found on page 150





# LAUDA Cooling thermostats

## Power supply variants

Device type	Power supply V; Hz	Heater power max. kW	Loading max. kW	Plug code*	Cat. No.	Device type	Power supply V; Hz	Heater power max. kW	Loading max. kW	Plug code*	Cat. No.
LAUDA PRO / Page 52											
RP 2040	100 V; 50/60 Hz	1.3	1.5	14	L000530	RP 3035 C	200 V; 50/60 Hz	2.7	3.2	31	L000508
RP 2040	100 V; 50/60 Hz	1.3	1.6	32	L000538	RP 3035 C	200 V; 50/60 Hz	2.7	3.2	2	L000476
RP 2040	120 V; 60 Hz	1.9	1.9	32	L000458	RP 3035 C	200 V; 50/60 Hz	2.7	3.2	32	L000524
RP 2040	120 V; 60 Hz	1.9	1.9	4	L000450	RP 3035 C	200 V; 50/60 Hz	2.7	3.2	3	L000492
RP 2040	200 V; 50/60 Hz	2.7	3.2	3	L000482	RP 3035 C	208-220 V; 60 Hz	3.3	3.5	32	L000444
RP 2040	200 V; 50/60 Hz	2.7	3.2	32	L000514	RP 3035 C	208-220 V; 60 Hz	3.3	3.5	3	L000316
RP 2040	200 V; 50/60 Hz	2.7	3.2	31	L000498	RP 3035 C	208-220 V; 60 Hz	3.3	3.5	31	L000428
RP 2040	200 V; 50/60 Hz	2.7	3.2	2	L000466	RP 3035 C	208-220 V; 60 Hz	3.3	3.5	2	L000574
RP 2040	208-220 V; 60 Hz	3.3	3.5	3	L000306	RP 1090	200 V; 50/60 Hz	2.7	3.2	32	L000517
RP 2040	208-220 V; 60 Hz	3.3	3.5	32	L000434	RP 1090	200 V; 50/60 Hz	2.7	3.2	3	L000485
RP 2040	208-220 V; 60 Hz	3.3	3.5	2	L000564	RP 1090	200 V; 50/60 Hz	2.7	3.2	31	L000501
RP 2040	208-220 V; 60 Hz	3.3	3.5	31	L000418	RP 1090	200 V; 50/60 Hz	2.7	3.2	2	L000469
RP 2040 C	100 V; 50/60 Hz	1.3	1.5	14	L000534	RP 1090	208-220 V; 60 Hz	3.3	3.5	3	L000309
RP 2040 C	100 V; 50/60 Hz	1.3	1.6	32	L000542	RP 1090	208-220 V; 60 Hz	3.3	3.5	32	L000437
RP 2040 C	120 V; 60 Hz	1.9	1.9	4	L000454	RP 1090	208-220 V; 60 Hz	3.3	3.5	2	L000567
RP 2040 C	120 V; 60 Hz	1.9	1.9	32	L000462	RP 1090	208-220 V; 60 Hz	3.3	3.5	31	L000421
RP 2040 C	200 V; 50/60 Hz	2.7	3.2	2	L000474	RP 1090 C	200 V; 50/60 Hz	2.7	3.2	3	L000493
RP 2040 C	200 V; 50/60 Hz	2.7	3.2	32	L000522	RP 1090 C	200 V; 50/60 Hz	2.7	3.2	32	L000525
RP 2040 C	200 V; 50/60 Hz	2.7	3.2	3	L000490	RP 1090 C	200 V; 50/60 Hz	2.7	3.2	31	L000509
RP 2040 C	200 V; 50/60 Hz	2.7	3.2	31	L000506	RP 1090 C	200 V; 50/60 Hz	2.7	3.2	2	L000477
RP 2040 C	208-220 V; 60 Hz	3.3	3.5	32	L000442	RP 1090 C	208-220 V; 60 Hz	3.3	3.5	3	L000317
RP 2040 C	208-220 V; 60 Hz	3.3	3.5	3	L000314	RP 1090 C	208-220 V; 60 Hz	3.3	3.5	2	L000575
RP 2040 C	208-220 V; 60 Hz	3.3	3.5	31	L000426	RP 1090 C	208-220 V; 60 Hz	3.3	3.5	32	L000445
RP 2040 C	208-220 V; 60 Hz	3.3	3.5	2	L000572	RP 1090 C	208-220 V; 60 Hz	3.3	3.5	31	L000429
RP 2045	200 V; 50/60 Hz	2.7	3.2	31	L000499	RP 2090	200 V; 50/60 Hz	2.7	3.2	32	L000518
RP 2045	200 V; 50/60 Hz	2.7	3.2	3	L000483	RP 2090	200 V; 50/60 Hz	2.7	3.2	31	L000502
RP 2045	200 V; 50/60 Hz	2.7	3.2	2	L000467	RP 2090	200 V; 50/60 Hz	2.7	3.2	3	L000486
RP 2045	200 V; 50/60 Hz	2.7	3.2	32	L000515	RP 2090	200 V; 50/60 Hz	2.7	3.2	2	L000470
RP 2045	208-220 V; 60 Hz	3.3	3.5	32	L000435	RP 2090	208-220 V; 60 Hz	3.3	3.5	2	L000568
RP 2045	208-220 V; 60 Hz	3.3	3.5	3	L000307	RP 2090	208-220 V; 60 Hz	3.3	3.5	31	L000422
RP 2045	208-220 V; 60 Hz	3.3	3.5	2	L000565	RP 2090	208-220 V; 60 Hz	3.3	3.5	3	L000310
RP 2045	208-220 V; 60 Hz	3.3	3.5	31	L000419	RP 2090	208-220 V; 60 Hz	3.3	3.5	32	L000438

\*All data for the plug codes can be found on page 150 All device types with mark ›W‹ are water-cooled

Device type	Power supply V; Hz	Heater power max. kW	Loading max. kW	Plug code*	Cat. No.	Device type	Power supply V; Hz	Heater power max. kW	Loading max. kW	Plug code*	Cat. No.
<b>LAUDA PRO / Page 52</b>											
RP 2045 C	200 V; 50/60 Hz	2.7	3.2	3	L000491	RP 2090 C	200 V; 50/60 Hz	2.7	3.2	2	L000478
RP 2045 C	200 V; 50/60 Hz	2.7	3.2	31	L000507	RP 2090 C	200 V; 50/60 Hz	2.7	3.2	3	L000494
RP 2045 C	200 V; 50/60 Hz	2.7	3.2	2	L000475	RP 2090 C	200 V; 50/60 Hz	2.7	3.2	31	L000510
RP 2045 C	200 V; 50/60 Hz	2.7	3.2	32	L000523	RP 2090 C	200 V; 50/60 Hz	2.7	3.2	32	L000526
RP 2045 C	208-220 V; 60 Hz	3.3	3.5	2	L000573	RP 2090 C	208-220 V; 60 Hz	3.3	3.5	2	L000576
RP 2045 C	208-220 V; 60 Hz	3.3	3.5	32	L000443	RP 2090 C	208-220 V; 60 Hz	3.3	3.5	32	L000446
RP 2045 C	208-220 V; 60 Hz	3.3	3.5	31	L000427	RP 2090 C	208-220 V; 60 Hz	3.3	3.5	3	L000318
RP 2045 C	208-220 V; 60 Hz	3.3	3.5	3	L000315	RP 2090 C	208-220 V; 60 Hz	3.3	3.5	31	L000430
RP 3035	100 V; 50/60 Hz	1.3	1.5	14	L000531	RP 10100	200 V; 50/60 Hz	2.7	3.2	2	L000471
RP 3035	100 V; 50/60 Hz	1.3	1.6	32	L000539	RP 10100	200 V; 50/60 Hz	2.7	3.2	3	L000487
RP 3035	120 V; 60 Hz	1.9	1.9	4	L000451	RP 10100	200 V; 50/60 Hz	2.7	3.2	31	L000503
RP 3035	120 V; 60 Hz	1.9	1.9	32	L000459	RP 10100	200 V; 50/60 Hz	2.7	3.2	32	L000519
RP 3035	200 V; 50/60 Hz	2.7	3.2	31	L000500	RP 10100	208-220 V; 60 Hz	3.3	3.5	3	L000311
RP 3035	200 V; 50/60 Hz	2.7	3.2	3	L000484	RP 10100	208-220 V; 60 Hz	3.3	3.5	31	L000423
RP 3035	200 V; 50/60 Hz	2.7	3.2	32	L000516	RP 10100	208-220 V; 60 Hz	3.3	3.5	2	L000569
RP 3035	200 V; 50/60 Hz	2.7	3.2	2	L000468	RP 10100	208-220 V; 60 Hz	3.3	3.5	32	L000439
RP 3035	208-220 V; 60 Hz	3.3	3.5	2	L000566	RP 10100 C	200 V; 50/60 Hz	2.7	3.2	31	L000511
RP 3035	208-220 V; 60 Hz	3.3	3.5	32	L000436	RP 10100 C	200 V; 50/60 Hz	2.7	3.2	2	L000479
RP 3035	208-220 V; 60 Hz	3.3	3.5	3	L000308	RP 10100 C	200 V; 50/60 Hz	2.7	3.2	3	L000495
RP 3035	208-220 V; 60 Hz	3.3	3.5	31	L000420	RP 10100 C	200 V; 50/60 Hz	2.7	3.2	32	L000527
RP 3035 C	100 V; 50/60 Hz	1.3	1.5	14	L000535	RP 10100 C	208-220 V; 60 Hz	3.3	3.5	2	L000577
RP 3035 C	100 V; 50/60 Hz	1.3	1.6	32	L000543	RP 10100 C	208-220 V; 60 Hz	3.3	3.5	3	L000319
RP 3035 C	120 V; 60 Hz	1.9	1.9	32	L000463	RP 10100 C	208-220 V; 60 Hz	3.3	3.5	31	L000431
RP 3035 C	120 V; 60 Hz	1.9	1.9	4	L000455	RP 10100 C	208-220 V; 60 Hz	3.3	3.5	32	L000447

**LAUDA Proline Kryomats / Page 54**

RP 4050 C	200 V; 3/PE; 50/60 Hz	2.8	5.0	20	L001701	RP 3090 CW	200 V; 3/PE; 50/60 Hz	2.8	5.0	20	L001706
RP 4050 C	208 V; 3/PE; 60 Hz	3.0	5.0	20	L001677	RP 3090 CW	208 V; 3/PE; 60 Hz	3.0	5.0	20	L001682
RP 4050 CW	200 V; 3/PE; 50/60 Hz	2.8	5.0	20	L001705	RP 4090 C	200 V; 3/PE; 50/60 Hz	2.8	7.0	20	L001703
RP 4050 CW	208 V; 3/PE; 60 Hz	3.0	5.0	20	L001681	RP 4090 C	208 V; 3/PE; 60 Hz	3.0	7.0	20	L001679
RP 3090 C	200 V; 3/PE; 50/60 Hz	2.8	5.0	20	L001702	RP 4090 CW	200 V; 3/PE; 50/60 Hz	2.8	7.0	20	L001707
RP 3090 C	208 V; 3/PE; 60 Hz	3.0	7.0	20	L001678	RP 4090 CW	208 V; 3/PE; 60 Hz	3.0	5.0	20	L001683

# LAUDA Cooling thermostats

## More characteristics

LAUDA Alpha / Page 48

### PUMP CHARACTERISTIC Water

Pressure bar

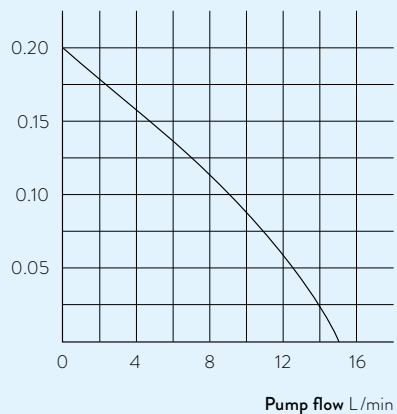

LAUDA ECO / Page 50

### COOLING PERFORMANCE According to DIN 12876

Bath temperature °C

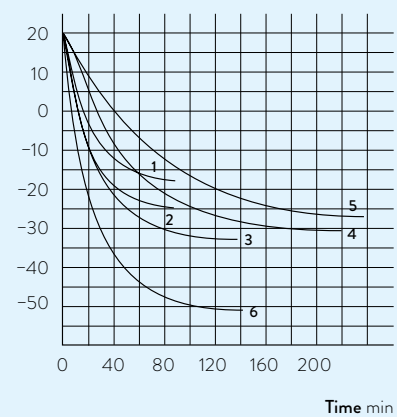

- 1 RE 415 S
- 2 RE 420 S
- 3 RE 630 S
- 4 RE 1225 S
- 5 RE 2025 S
- 6 RE 1050 S

**COOLING PERFORMANCE** According to DIN 12876

Bath temperature °C

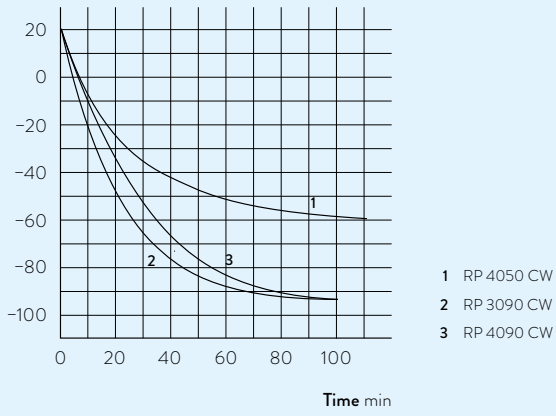

- 1 RP 4050 CW
- 2 RP 3090 CW
- 3 RP 4090 CW

# LAUDA CIRCULATION AND PROCESS THERMOSTATS

## Specific application examples

- Refractometer
- Polarimeter
- Single-use bioreactors
- Extruder for food micro reactors
- Responsive control in chemical/pharmaceutical surroundings
- Climate chambers
- Space simulation
- Electric mobility; battery testing
- Test rigs
- Stress test
- Crystallization regulation
- Freeze-drying
- Micro structures
- Coating plants



PRO  
RP 245 E

LAUDA



# LAUDA LOOP

The compact, lightweight circulation thermostat for external applications from 4 to 80 °C

4°C  80°C

## Extremely versatile, flexibly usable thermo-electric circulation thermostat

The LAUDA LOOP circulation thermostat is sure to impress with its constant temperature range between 4 and 80 °C and astonishing flexibility. Its compact construction and low weight, as well as wide voltage input range of 100 to 240 volts, make it possible to put it to use flexibly and spontaneously anywhere in the world – the ›Plug and Play‹ setup with quick-fit couplings makes it especially easy to use. The intuitive three-button softkey operation and simple menu navigation in five available languages via the well-lit, high-contrast OLED display make using the device a breeze.



Simple three-button controls with OLED display



Standard-issue RS 232 interface for system integration into processes

## PUMP CHARACTERISTIC Water

Pressure bar

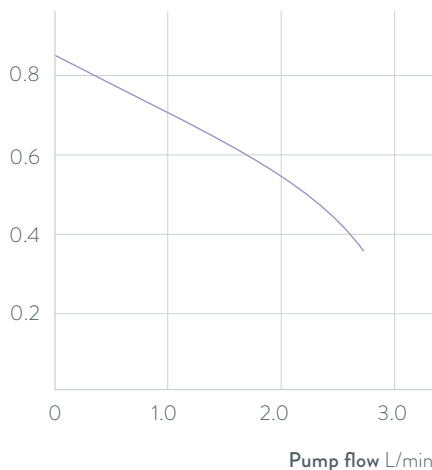

## Important functions

- Pump connections with quick-fit couplings for easy consumer changes
- Can be operated with non-flammable liquids (water, water/glycol)
- Cooling technology free of coolant ensures silent, low-vibration operation

## Included accessories

Hose nozzles for pump connections

## Further accessories

Tubing

All technical data and power supply variants can be found in the ›Technical data‹ section.

More at [www.lauda.de/1748](http://www.lauda.de/1748)





### LAUDA LOOP

The L100 and L250 air-cooled device types achieve a cooling capacity of 120 and 250 watt. The devices are primarily for use at constant temperatures with low power requirements. Both device types are especially energy-efficient and silent in partial-load operation.



# LAUDA PRO

Compact circulation thermostats for professional temperature control from  $-90$  to  $250$  °C



## Flexible operation, outstanding performance characteristics

LAUDA PRO is the cutting-edge product line with an outstanding overall concept: Brandnew from LAUDA are the circulation thermostats for external use, with small, active liquid volumes for quick temperature changes. The innovative Base or Command Touch operating units can be detached and used as a remote control. The cooling thermostats come equipped with hybrid cooling as standard, which allows for additional cooling of the refrigerating machine with water.

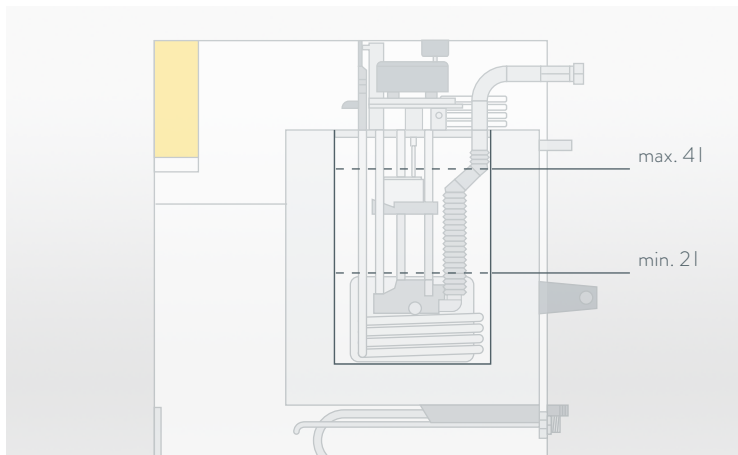

The small filling volume and powerful vario flex pump offer fast temperature changes with low operating costs and material consumption



Low device height and removable remote control unit

## PUMP CHARACTERISTICS Water

Pressure bar

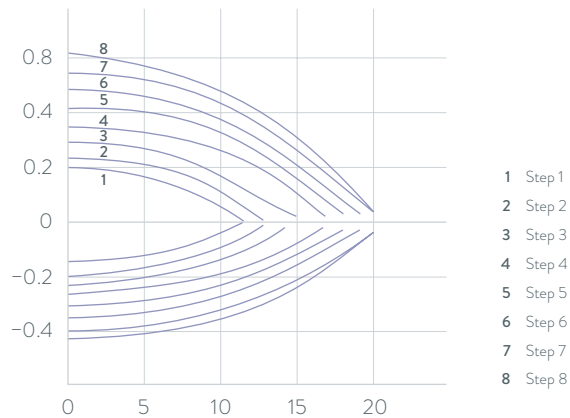

Suction

Pump flow L/min

## Important functions

- Tower design for small footprint
- LAUDA Vario Flex Pump with 8 available output levels, pump connections at rear
- SmartCool system for digital, energy-saving cooling control including automatic compressor control

## Included accessories

Tubing nipples for pumps and cooling water connection

## Further accessories

Tubing, interface modules

All technical data and power supply variants can be found in the ›Technical data‹ section.

More at [www.lauda.de/1750](http://www.lauda.de/1750)



## LAUDA PRO

The PRO heating circulation thermostats are designed for external applications up to 250 °C. The compact construction permits space-saving installation of the thermostats. An integrated cooling coil, fitted as standard, provides cooling. The PRO cooling circulation thermostats are ideal for external applications where rapid temperature changes are required. The cooling output of 0.6 and 0.8 kW or 1.5 kW, combined with a very low filling volume permit these rapid temperature changes.



# LAUDA Integral T

Process thermostats for professional external temperature control in the temperature range of  $-30$  to  $120$  °C



## High-performance process thermostats for effective control of external temperature control processes

The mobile Integral T process thermostats have an adjustable heating and cooling capacity and small, active internal volume that enables fast temperature changes. The minimized thermal ballast makes it possible to control exothermal reactions or simulate climatic influences, for example. Starting with the T 4600 model, the Integral Ts are equipped with an additional pump for independent internal circulation within the internal loop. An adjustable bypass valve between the inlet and outlet of the external loop also enables a reduction in pressure to protect, for example, pressure-sensitive consumers.



Fold-out control unit with large display and easily accessible interfaces



All devices are equipped with castors

## PUMP CHARACTERISTICS Liquid: Kryo 30

Pressure bar

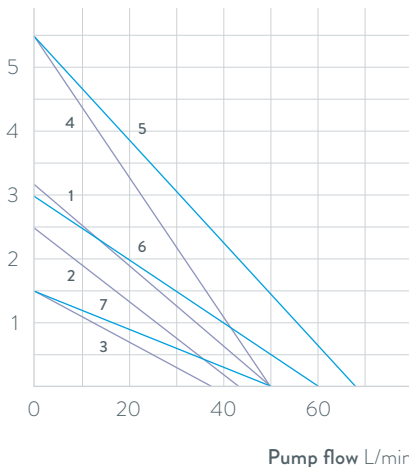

- T 2200, T 2200 W
- T 4600, T 4600 W
- 1 Bypass closed
- 2 Bypass 2.5 bar max.
- 3 Bypass 1.5 bar max.
- 4 Option high-power pump 5.5 bar
- T 7000, T 7000 W
- T 10000, T 10000 W
- 5 Bypass closed
- 6 Bypass 3.0 bar max.
- 7 Bypass 1.5 bar max.

### Important functions

- Filler nozzle on front, drain tap at the rear
- Small stainless steel bath with large expansion volume
- Programmer with max. 150 segments, 5 program parts
- Automatic proportional cooling with compressor control

### Included accessories

Nipples for pump connections

### Further accessories

Tubing, 4-port manifold

All technical data and power supply variants can be found in the ›Technical data‹ section.

More at [www.lauda.de/1752](http://www.lauda.de/1752)



### LAUDA Integral T

The T control unit can be easily folded out, making the following interfaces accessible from below: Connector for standby contact input, fault (alarm) contact output, analog inputs and outputs, external Pt100 and serial RS-232-/485 interface.



# LAUDA Integral XT

High-performance process thermostats from 1.5 to 18 kW for temperature control from  $-90$  to  $320$  °C



## Process thermostats for dynamic temperature control tasks

The Integral XT process thermostats operate according to the flow principle with a cold oil blanket that allows the utilization of a wide temperature range through the use of a heat transfer medium. The electronically controlled, magnetically coupled pump can alter the pressure to adapt the flow rate to the relevant process requirements. The Integral XT models can be integrated easily in different process control systems using a wide selection of interface modules.

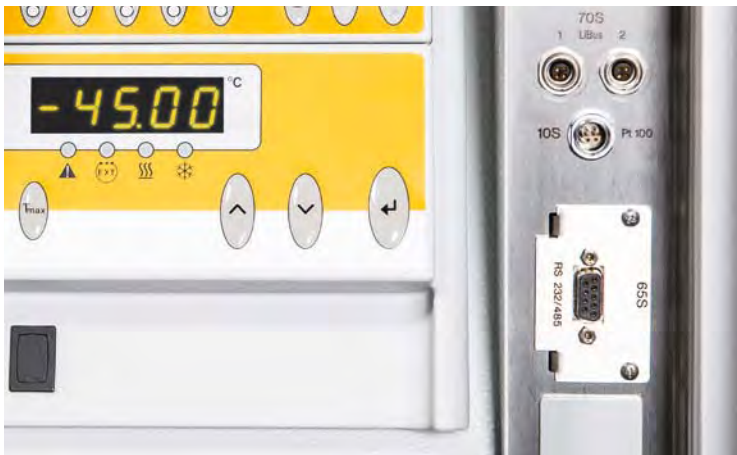

Standard-issue RS 232/485 interface and two other insertion locations for interface modules in the interest of flexible system integration



Simple and intuitive operation thanks to detachable remote control

## PUMP CHARACTERISTICS\* Water

Pressure bar

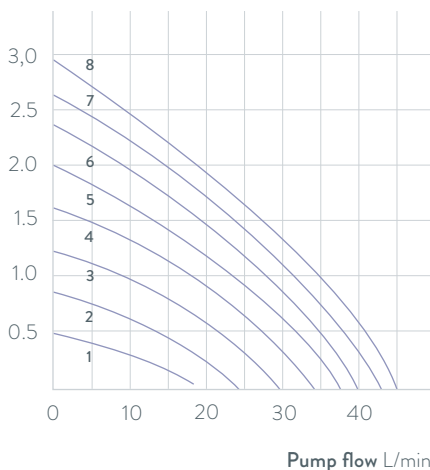

- 1 Step 1
- 2 Step 2
- 3 Step 3
- 4 Step 4
- 5 Step 5
- 6 Step 6
- 7 Step 7
- 8 Step 8

\* for all XT (except XT 1850 W / 1850 WS)

## Important functions

- High-performance LAUDA Vario Pump (pressure pump) with 8 selectable output levels or flow pressure control
- Retrofittable with up to 2 additional interface modules
- Programmer with 150 temperature/time segments, can be divided into 5 programs
- SmartCool system for energy-saving digital cooling control including automatic compressor control

## Included accessories

Command remote control with RS-232/485 interface

## Further accessories

Tubing, interface modules, adapter

All technical data and power supply variants can be found in the »Technical data« section.

More at [www.lauda.de/1754](http://www.lauda.de/1754)



### LAUDA Integral XT

The process thermostats can be operated easily and intuitively using the detachable Command remote control with plain text menu guidance and graphic display of the temperature profile.



# LAUDA Variocool

Cooling circulation thermostats from  $-20$  to  $80$  °C  
with cooling capacities up to 10 kW and powerful pumps

$-20$  °C   $80$  °C

## Comprehensive spectrum of services for demanding temperature control tasks

The LAUDA Variocool with optional heater is a fully fledged circulation thermostat suitable for use with non-flammable heat transfer liquid within a moderate temperature range.

Equipment incorporating different pumps, individual interface module expansions and the option of external temperature control allow operation as a standalone unit or full integration in a process control system.



All models are equipped with electronic expansion valve



Flexible customization to applications due to optional heating and high performance pumps

## PUMP CHARACTERISTIC Water

Pressure bar

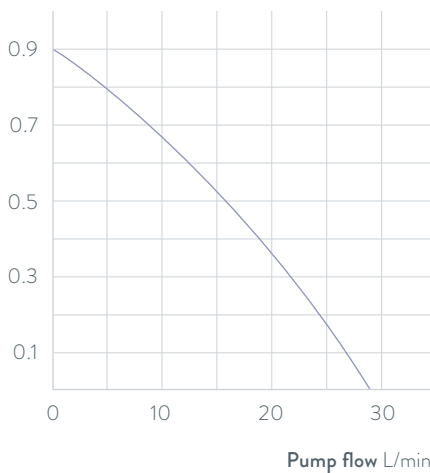

## Important functions

- Adjustable bypass for pressure limitation
- Filling opening at the top, drain tap at the rear
- Integrated programmer with 150 segments, can be divided into 5 programs
- Electronic level indicator and low-level alarm
- SmartCool system for digital, energy-saving cooling control, including automatic compressor control

## Included accessories

Nipples, screw caps

## Further accessories

Hoses, interface modules

All technical data and power supply variants can be found in the ›Technical data‹ section.

More at [www.lauda.de/1756](http://www.lauda.de/1756)





### LAUDA Variocool

All models are available in air and water-cooled versions (W) and fitted with moveable as well as fixable castors. High-performance circulation chillers in a tower design starting from the VC 5000 model are available with sound insulation.



# LAUDA Kryoheater Selecta

Process thermostats from  $-90$  to  $200$  °C

for high-performance, professional temperature control



## High-performance temperature control – impressive energy efficiency and reliability

LAUDA process thermostats from the Kryoheater Selecta (KHS) product line are synonymous with high-performance temperature control, long service life, ease of maintenance and intuitive operation. Depending on the lowest required temperature, either a two-level compressor (down to  $-60$  °C) or a cascade cooling system (down to  $-90$  °C) is used. Condenser cooling is performed using cooling water and is controlled continuously and precisely. An incremental switch offers energy-saving and low-wear partial load operation via automatic compressor control.



Secure and reliable use in production environment thanks to protection class IP 54 and the durable steel frame construction of the device

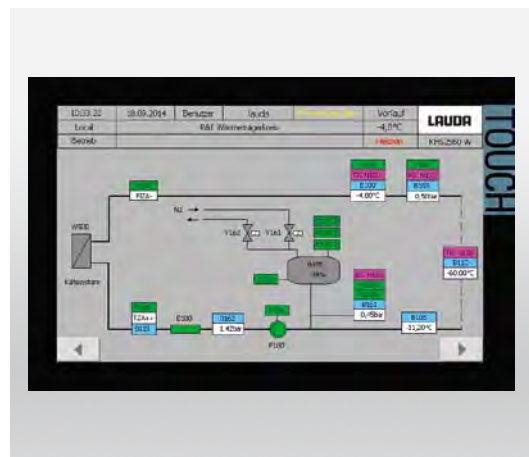

SPC controlling with 7" touch panel for intuitive operation and extensive data exchange with process control systems

## COOLING POWER Heat transfer liquid: Kryo 65 / Kryo 90

### Effective cooling power kW

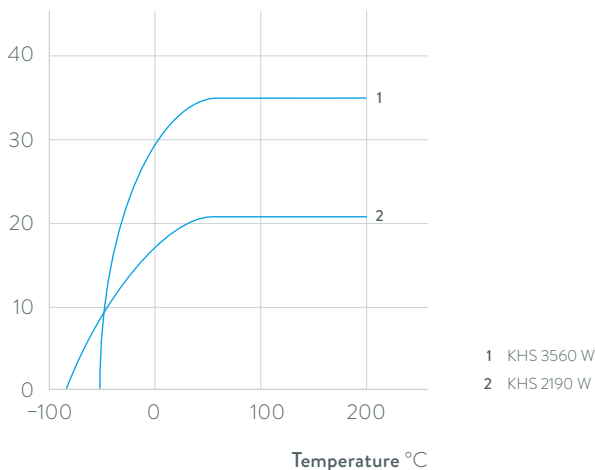

### Important functions

- Powerful, magnetically-coupled pump (high flow rate, even with pressure losses), speed-controlled or with flow pressure control
- Prepared for pressurized nitrogen overlay
- Visualization of pending faults, status display of all system components
- User management
- Free choice of analog or digital interface included in the standard delivery, other optional interfaces also available
- USB port and LEMO connector for external temperature probe as standard

### Available accessories

Thermostating and cooling water tubing, adapters

All technical data and power supply variants can be found in the ›Technical data‹ section.

More at [www.lauda.de/1758](http://www.lauda.de/1758)



### LAUDA Kryoheater Selecta

The Kryoheater Selecta product line consists of the two devices KHS 3560 W and KHS 2190 W, which can be used in chemical and pharmaceutical production. They also perform impressively in simulations of the environmental conditions at inspection stations in the automotive and aerospace industry. The process thermostats are designed for pressurized operation with nitrogen. Benefits include the increase in maximum operating temperature and the extension in service life of the heat transfer liquids.

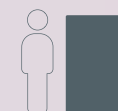

# LAUDA-Noah POU

Thermo-electric process thermostats  
for the semiconductor industry from  $-20$  to  $90^{\circ}\text{C}$



## Fast and precise temperature control for demanding processes

The thermoelectric point of use (POU) temperature control system offers reproducible temperature control for plasma etching applications. This system dynamically controls the temperature of the electrostatic wafer chuck (ESC) and can be used in all types of etching processes. The LAUDA-Noah POU thermoelectric temperature control systems are based on established principles of heat transfer used for Peltier elements. These elements allow quick and precise temperature control required for complex processes involved in the manufacture of components progressively getting smaller and smaller in size.



Dynamic, stable temperature control

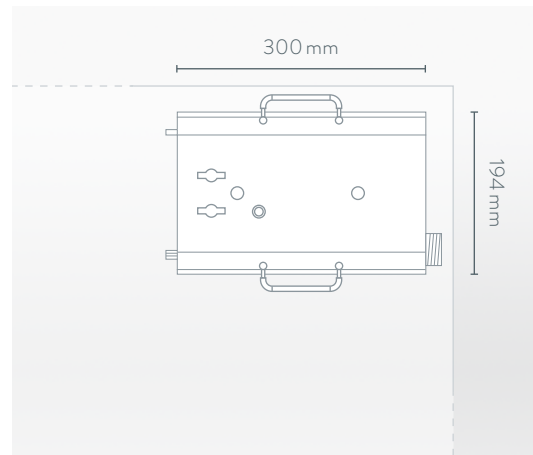

Small footprint

## COOLING POWER dependent on process temperature

Effective cooling power kW

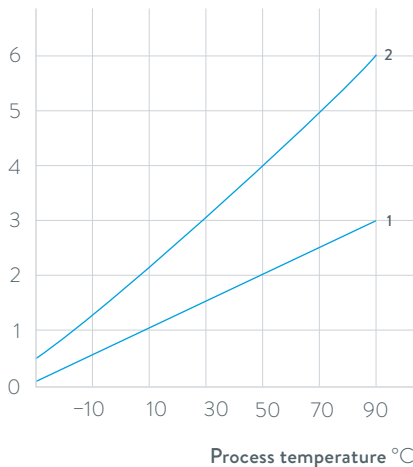

1 POU 3300  
2 POU 2400, POU 3500

## Important functions

- Compressor and refrigerant-free system with low energy consumption
- Smallest footprint in the industry, no footprint required for underfloor installation
- Extremely low volume of heat transfer fluid

## Included accessories

Canister with hand pump for filling

## Further accessories

Communications modules with remote control function (RS-485 protocol)

All technical data and power supply variants can be found in the [Technical data](#) section.

More at [www.lauda.de/1760](http://www.lauda.de/1760)



### LAUDA-Noah POU

Point of use (POU) temperature control systems can reduce energy consumption by up to 90 % compared to compressor-based systems. Minimal space requirements with the option of underfloor installation at the point of use minimizes cleanroom use.



# LAUDA Circulation and process thermostats

## Device type overview

LAUDA LOOP / Page 72

LAUDA PRO / Page 74



LAUDA Integral T / Page 76



LAUDA Integral XT / Page 78



LAUDA Variocool / Page 80



# LAUDA Circulation and process thermostats

## Interfaces

	Pt 100	USB	Ethernet	RS 232 / 485	Analog	Namur contact	Sub-D contact	Profibus	EtherCat M8	EtherCat RJ 45	Modbus	Profinet	Malfunction contact	Number of module slots, large	Number of module slots, small
LAUDA LOOP / Page 72	-	-	-	S	-	-	-	-	-	-	-	-	-	-	-
LAUDA PRO / Page 74	S	S	S	Z	Z	Z	Z	Z	Z	Z	-	-	-	1	-
LAUDA Integral T / Page 76	S	-	-	S	S	-	-	-	-	-	-	-	S	-	-
LAUDA Integral XT / Page 78	S	Z	Z	S	Z	Z	Z	Z	Z	Z	-	-	-	2	-
LAUDA Variocool / Page 80	Z	S	Z	Z	Z	Z	Z	Z	Z	Z	-	-	S	1	1
LAUDA Kryoheater Selecta / Page 82	S	S	-	OD	OD	-	-	OD	-	OD	-	OD	-	-	-

S = Series standard  
 Z = Available as an accessory  
 OD = optional (cannot be retrofitted)



LRZ 912  
Analog module



LRZ 913  
RS 232/485 interface



LRZ 914  
Contact module with single input and single output (NAMUR)



LRZ 915  
Contact module with 3 inputs and 3 outputs



LRZ 917  
Profibus module



LRZ 918  
Pt100/Li bus module



LRZ 921  
Ethernet module



LRZ 922  
EtherCAT module with M8 connection



LRZ 923  
EtherCAT module with RJ45 connection

### LAUDA Kryoheater Selecta / Page 82



KHS 3560 W  
KHS 2190 W

### LAUDA-Noah POU / Page 84



POU 2400  
POU 3300



POU 3500

# LAUDA Circulation and process thermostats

## Function overview

Operating element	LOOP	PROE	PROEC	Variocool	Integral T	Integral XT	Kryoheater Selecta
Display	OLED	OLED	TFT	TFT	LCD mono	LCD mono	TFT
Mode of operation	3-button softkey	Cursor softkey	Multi-touch	Cursor softkey	3-button softkey	Cursor softkey	Multi-touch
Removable control	-	√	√	-	-	√	-
User management	-	-	√	-	-	-	√
Data logging, export to USB stick	-	-	√	-	-	-	√
1-point calibration	√	√	√	√	√	√	-
2-point calibration	√	√	√	-	-	-	-
Programmer, programs/segments	-	1 / 20	100 / 5000	5 / 150	5 / 150	5 / 150	OD
Programmer, tolerance range function	-	√	√	√	√	√	OD
Ramp function	-	-	-	-	-	-	OD
Timer function	-	-	√	-	-	√	-
Countdown function	-	-	√	-	-	√	-
Graphic temperature profile display	-	-	√	√	-	√	√
Pump pressure display (digital)	-	-	-	-	√	√	√
Adjustable bypass	-	-	-	√	√	Z	-
Level indicator (analog)	-	-	-	-	√	-	-
Level indicator (digital)	-	√	√	√	-	√	√
Standby timer	√	√	√	√	√	√	√
Flow control instrument	-	-	-	Z	OD	-	-
Flow measurement + control	-	-	-	-	-	Z	OD
Overflow	-	√	√	-	√	√	√
Low-level alarm	-	√	√	√	√	√	√
Drain tap	-	√	√	√	√	√	√

Z = Available as an accessory

OD = optional (cannot be retrofitted)





# LAUDA Circulation and process thermostats

Technical data according to DIN 12876 standard

Device type	Working temperature range °C	Temperature stability ±K	Heat discharge cooling unit	Heater power max. kW	Cooling output kW														
					200 °C	100 °C	20 °C	10 °C	0 °C	-10 °C	-20 °C	-30 °C	-40 °C	-50 °C	-60 °C	-70 °C	-80 °C	-90 °C	
<b>LAUDA LOOP / Page 72</b>																			
LOOP 250	4...80	0.10	Air	0.4	-	-	0.25	0.13	-	-	-	-	-	-	-	-	-	-	-
LOOP 100	4...80	0.10	Air	0.2	-	-	0.12	0.06	-	-	-	-	-	-	-	-	-	-	-
<b>LAUDA PRO / Page 74</b>																			
P 2 E	80...250	0.05	-	2.5	-	-	-	-	-	-	-	-	-	-	-	-	-	-	-
P 2 EC	80...250	0.05	-	2.5	-	-	-	-	-	-	-	-	-	-	-	-	-	-	-
RP 240 E	-40...200	0.05	Hybrid	2.5	-	-	0.60 <sup>3</sup>	0.60 <sup>3</sup>	0.60 <sup>3</sup>	0.41 <sup>3</sup>	0.24 <sup>2</sup>	0.12 <sup>2</sup>	0.02 <sup>2</sup>	-	-	-	-	-	-
RP 240 EC	-40...200	0.05	Hybrid	2.5	-	-	0.60 <sup>3</sup>	0.60 <sup>3</sup>	0.60 <sup>3</sup>	0.41 <sup>3</sup>	0.24 <sup>2</sup>	0.12 <sup>2</sup>	0.02 <sup>2</sup>	-	-	-	-	-	-
RP 245 E	-45...200	0.05	Hybrid	2.5	-	-	0.80 <sup>3</sup>	0.80 <sup>3</sup>	0.80 <sup>3</sup>	0.53 <sup>3</sup>	0.34 <sup>2</sup>	0.15 <sup>2</sup>	0.04 <sup>2</sup>	-	-	-	-	-	-
RP 245 EC	-45...200	0.05	Hybrid	2.5	-	-	0.80 <sup>3</sup>	0.80 <sup>3</sup>	0.80 <sup>3</sup>	0.53 <sup>3</sup>	0.34 <sup>2</sup>	0.15 <sup>2</sup>	0.04 <sup>2</sup>	-	-	-	-	-	-
RP 250 E	-50...200	0.05	Hybrid	2.5	-	-	1.50 <sup>3</sup>	1.44 <sup>3</sup>	1.20 <sup>3</sup>	0.84 <sup>3</sup>	0.54 <sup>2</sup>	0.29 <sup>2</sup>	0.11 <sup>2</sup>	0.02 <sup>1</sup>	-	-	-	-	-
RP 250 EC	-50...200	0.05	Hybrid	2.5	-	-	1.50 <sup>3</sup>	1.44 <sup>3</sup>	1.20 <sup>3</sup>	0.84 <sup>3</sup>	0.54 <sup>2</sup>	0.29 <sup>2</sup>	0.11 <sup>2</sup>	0.02 <sup>1</sup>	-	-	-	-	-
RP 290 E	-90...200	0.05	Hybrid	2.5	-	-	0.80 <sup>3</sup>	0.77 <sup>3</sup>	0.74 <sup>3</sup>	0.72 <sup>3</sup>	0.70 <sup>2</sup>	0.68 <sup>2</sup>	0.64 <sup>2</sup>	0.56 <sup>2</sup>	0.39 <sup>2</sup>	0.21 <sup>2</sup>	0.09 <sup>2</sup>	0.01 <sup>1</sup>	-
RP 290 EC	-90...200	0.05	Hybrid	2.5	-	-	0.80 <sup>3</sup>	0.77 <sup>3</sup>	0.74 <sup>3</sup>	0.72 <sup>3</sup>	0.70 <sup>2</sup>	0.68 <sup>2</sup>	0.64 <sup>2</sup>	0.56 <sup>2</sup>	0.39 <sup>2</sup>	0.21 <sup>2</sup>	0.09 <sup>2</sup>	0.01 <sup>1</sup>	-
<b>LAUDA Integral T / Page 76</b>																			
T 2200	-25...120	0.20	Air	2.3	-	-	2.20	1.80	1.40	1.00	0.60	-	-	-	-	-	-	-	-
T 2200	-25...120	0.20	Air	2.3	-	-	2.20	1.80	1.40	1.00	0.60	-	-	-	-	-	-	-	-
T 2200	-25...120	0.20	Air	2.3	-	-	2.00	1.60	1.20	0.80	0.40	-	-	-	-	-	-	-	-
T 2200 W	-25...120	0.20	Water	2.3	-	-	2.70	2.30	1.90	1.40	0.68	-	-	-	-	-	-	-	-
T 2200 W	-25...120	0.20	Water	2.3	-	-	2.70	2.30	1.90	1.40	0.68	-	-	-	-	-	-	-	-
T 2200 W	-25...120	0.20	Water	2.3	-	-	2.50	2.10	1.70	1.20	0.48	-	-	-	-	-	-	-	-
T 4600	-30...120	0.20	Air	6.0	-	-	4.60	3.70	2.80	1.90	1.00	0.20	-	-	-	-	-	-	-
T 4600	-30...120	0.20	Air	6.0	-	-	4.40	3.50	2.60	1.70	0.80	-	-	-	-	-	-	-	-
T 4600 W	-30...120	0.20	Water	6.0	-	-	5.50	4.50	3.40	2.30	1.10	0.30	-	-	-	-	-	-	-
T 4600 W	-30...120	0.20	Water	6.0	-	-	5.30	4.30	3.20	2.10	0.90	0.10	-	-	-	-	-	-	-
T 7000	-30...120	0.30	Air	6.0	-	-	7.00	6.00	5.00	3.00	1.70	0.50	-	-	-	-	-	-	-
T 7000 W	-30...120	0.30	Water	6.0	-	-	8.50	7.00	5.50	3.90	2.00	0.60	-	-	-	-	-	-	-
T 10000	-30...120	0.30	Air	9.0	-	-	10.00	9.00	7.30	5.10	3.00	1.20	-	-	-	-	-	-	-
T 10000 W	-30...120	0.30	Water	9.0	-	-	13.00	11.00	8.70	6.00	3.70	1.50	-	-	-	-	-	-	-

<sup>1</sup>Pump output step 2 <sup>2</sup>Pump output step 4 <sup>3</sup>Pump output step 8

Pump pressure max. bar	Pump flow max. pressure L/min	Pump connection thread mm	Bath volume min. L	Bath volume max. L	Dimensions (W x D x H) mm	Protection Rating	Noise level dB (A)	Weight kg	Loading max. kW	Power supply V; Hz	Cat. No.	Device type
0.8	2.6	Quick C. 1/4"	0.3	0.3	261×368×312	IP 21	57	11.9	0.4	100-240 V; 50/60 Hz	L000580	LOOP 250
0.8	2.6	Quick C. 1/4"	0.3	0.3	175×301×266	IP 21	57	6.9	0.2	100-240 V; 50/60 Hz	L000027	LOOP 100
0.7	22	M16×1	2.4	4.4	250×365×425	IP 21	47	15.5	2.7	200-230 V; 50/60 Hz	L000019	P 2 E
0.7	22	M16×1	2.4	4.4	250×365×425	IP 21	47	15.5	2.7	200-230 V; 50/60 Hz	L000020	P 2 EC
0.7	22	M16×1	2.4	4.4	300×430×675	IP 21	54	46.0	3.7	230 V; 50 Hz	L000021	RP 240 E
0.7	22	M16×1	2.4	4.4	300×430×675	IP 21	54	46.0	3.7	230 V; 50 Hz	L000023	RP 240 EC
0.7	22	M16×1	2.4	4.4	300×430×675	IP 21	54	46.0	3.7	230 V; 50 Hz	L000022	RP 245 E
0.7	22	M16×1	2.4	4.4	300×430×675	IP 21	54	46.0	3.7	230 V; 50 Hz	L000024	RP 245 EC
0.7	22	M16×1	2.4	4.4	300×430×675	IP 21	57	47.0	3.7	230 V; 50 Hz	L002494	RP 250 E
0.7	22	M16×1	2.4	4.4	300×430×675	IP 21	57	47.0	3.7	230 V; 50 Hz	L002495	RP 250 EC
0.7	22	M16×1	2.4	4.4	390×600×685	IP 21	56	79.0	3.7	230 V; 50 Hz	L002502	RP 290 E
0.7	22	M16×1	2.4	4.4	390×600×685	IP 21	56	79.0	3.7	230 V; 50 Hz	L002503	RP 290 EC
1.0	30	G 3/4	3.0	7.0	450×550×790	IP 32	60	89.0	3.1	230 V; 50 Hz	L001787	T 2200
3.2	40	G 3/4	3.0	7.0	450×550×790	IP 32	60	89.0	3.1	230 V; 50 Hz	L001710	T 2200
5.5	40	G 3/4	3.0	7.0	450×550×790	IP 32	60	89.0	3.1	230 V; 50 Hz	L001807	T 2200
1.0	30	G 3/4	3.0	7.0	450×550×790	IP 32	58	94.0	3.1	230 V; 50 Hz	L001788	T 2200 W
3.2	40	G 3/4	3.0	7.0	450×550×790	IP 32	58	94.0	3.1	230 V; 50 Hz	L001711	T 2200 W
5.5	40	G 3/4	3.0	7.0	450×550×790	IP 32	58	94.0	3.1	230 V; 50 Hz	L001808	T 2200 W
3.2	40	G 3/4	6.0	18.0	550×650×970	IP 32	63	123.0	8.5	400 V; 3/N/PE; 50 Hz	L001720	T 4600
5.5	40	G 3/4	6.0	18.0	550×650×970	IP 32	63	123.0	8.5	400 V; 3/N/PE; 50 Hz	L001825	T 4600
3.2	40	G 3/4	6.0	18.0	550×650×970	IP 32	61	128.0	8.3	400 V; 3/N/PE; 50 Hz	L001721	T 4600 W
5.5	40	G 3/4	6.0	18.0	550×650×970	IP 32	61	128.0	8.3	400 V; 3/N/PE; 50 Hz	L001826	T 4600 W
6.0	60	G 1 1/4	8.0	20.0	850×670×970	IP 32	65	175.0	11.5	400 V; 3/N/PE; 50 Hz	L001722	T 7000
6.0	60	G 1 1/4	8.0	20.0	850×670×970	IP 32	63	180.0	11.2	400 V; 3/N/PE; 50 Hz	L001723	T 7000 W
6.0	60	G 1 1/4	8.0	20.0	1050×770×1120	IP 32	69	235.0	16.0	400 V; 3/N/PE; 50 Hz	L001724	T 10000
6.0	60	G 1 1/4	8.0	20.0	850×670×970	IP 32	67	242.0	15.5	400 V; 3/N/PE; 50 Hz	L001725	T 10000 W

# LAUDA Circulation and process thermostats

Technical data according to DIN 12876 standard

Device type	Working temperature range °C	Temperature stability ±K	Heat discharge cooling unit	Heater power max. kW	Cooling output kW														
					200 °C	100 °C	20 °C	10 °C	0 °C	-10 °C	-20 °C	-30 °C	-40 °C	-50 °C	-60 °C	-70 °C	-80 °C	-90 °C	
<b>LAUDA Integral XT / Page 78</b>																			
XT 150	-45 ... 220	0.05	Air	3.6	1.50 <sup>1</sup>	1.50 <sup>1</sup>	1.50 <sup>1</sup>	1.30 <sup>1</sup>	1.10 <sup>1</sup>	1.00 <sup>1</sup>	0.62 <sup>1</sup>	0.28 <sup>1</sup>	0.06 <sup>1</sup>	-	-	-	-	-	
XT 250 W	-45 ... 220	0.05	Water	3.6	2.10 <sup>1</sup>	2.10 <sup>1</sup>	2.10 <sup>1</sup>	1.80 <sup>1</sup>	1.30 <sup>1</sup>	1.00 <sup>1</sup>	0.62 <sup>1</sup>	0.28 <sup>1</sup>	0.06 <sup>1</sup>	-	-	-	-	-	
XT 350 W	-50 ... 220	0.10	Water	3.6	3.10 <sup>2</sup>	3.10 <sup>2</sup>	3.10 <sup>2</sup>	3.10 <sup>2</sup>	3.10 <sup>2</sup>	2.00 <sup>2</sup>	1.20 <sup>2</sup>	0.70 <sup>2</sup>	0.25 <sup>1</sup>	0.02 <sup>1</sup>	-	-	-	-	
XT 550	-50 ... 220	0.05	Air	5.4	5.00 <sup>2</sup>	5.00 <sup>2</sup>	5.00 <sup>2</sup>	5.00 <sup>2</sup>	4.60 <sup>2</sup>	3.40 <sup>2</sup>	2.20 <sup>2</sup>	1.25 <sup>2</sup>	0.60 <sup>1</sup>	0.15 <sup>1</sup>	-	-	-	-	
XT 550 W	-50 ... 220	0.10	Water	5.4	5.40 <sup>2</sup>	5.40 <sup>2</sup>	5.40 <sup>2</sup>	5.40 <sup>2</sup>	5.40 <sup>2</sup>	4.30 <sup>2</sup>	2.90 <sup>2</sup>	1.60 <sup>2</sup>	0.80 <sup>1</sup>	0.15 <sup>1</sup>	-	-	-	-	
XT 750	-50 ... 220	0.05	Air	5.4	7.00 <sup>2</sup>	7.00 <sup>2</sup>	6.70 <sup>2</sup>	6.10 <sup>2</sup>	4.80 <sup>2</sup>	3.40 <sup>2</sup>	2.20 <sup>2</sup>	1.25 <sup>2</sup>	0.60 <sup>1</sup>	0.30 <sup>1</sup>	-	-	-	-	
XT 750 S	-50 ... 220	0.05	Air	8.0	7.00 <sup>2</sup>	7.00 <sup>2</sup>	6.70 <sup>2</sup>	6.10 <sup>2</sup>	4.80 <sup>2</sup>	3.40 <sup>2</sup>	2.20 <sup>2</sup>	1.25 <sup>2</sup>	0.60 <sup>1</sup>	0.30 <sup>1</sup>	-	-	-	-	
XT 950 W	-50 ... 220	0.10	Water	5.4	9.00 <sup>2</sup>	9.00 <sup>2</sup>	9.00 <sup>2</sup>	7.50 <sup>2</sup>	6.60 <sup>2</sup>	4.60 <sup>2</sup>	3.00 <sup>2</sup>	1.70 <sup>2</sup>	0.90 <sup>1</sup>	0.35 <sup>1</sup>	-	-	-	-	
XT 950 WS	-50 ... 220	0.10	Water	8.0	9.00 <sup>2</sup>	9.00 <sup>2</sup>	9.00 <sup>2</sup>	7.50 <sup>2</sup>	6.60 <sup>2</sup>	4.60 <sup>2</sup>	3.00 <sup>2</sup>	1.70 <sup>2</sup>	0.90 <sup>1</sup>	0.35 <sup>1</sup>	-	-	-	-	
XT 1850 W	-50 ... 220	0.30	Water	10.8	18.50 <sup>2</sup>	18.50 <sup>2</sup>	18.50 <sup>2</sup>	12.50 <sup>2</sup>	10.30 <sup>2</sup>	7.70 <sup>2</sup>	5.90 <sup>2</sup>	3.80 <sup>2</sup>	2.20 <sup>1</sup>	1.20 <sup>1</sup>	-	-	-	-	
XT 1850 WS	-50 ... 220	0.30	Water	16.0	18.50 <sup>2</sup>	18.50 <sup>2</sup>	18.50 <sup>2</sup>	12.50 <sup>2</sup>	10.30 <sup>2</sup>	7.70 <sup>2</sup>	5.90 <sup>2</sup>	3.80 <sup>2</sup>	2.20 <sup>1</sup>	1.20 <sup>1</sup>	-	-	-	-	
XT 280	-80 ... 220	0.10	Air	4.0	1.50 <sup>1</sup>	1.50 <sup>1</sup>	1.50 <sup>1</sup>	1.50 <sup>1</sup>	1.40 <sup>1</sup>	1.40 <sup>1</sup>	1.30 <sup>1</sup>	1.30 <sup>1</sup>	1.30 <sup>1</sup>	1.20 <sup>1</sup>	1.00 <sup>1</sup>	0.40 <sup>1</sup>	0.10 <sup>1</sup>	-	
XT 280 W	-80 ... 220	0.10	Water	4.0	2.00 <sup>1</sup>	2.00 <sup>1</sup>	2.00 <sup>1</sup>	2.00 <sup>1</sup>	2.00 <sup>1</sup>	1.90 <sup>1</sup>	1.80 <sup>1</sup>	1.70 <sup>1</sup>	1.60 <sup>1</sup>	1.40 <sup>1</sup>	1.00 <sup>1</sup>	0.40 <sup>1</sup>	0.10 <sup>1</sup>	-	
XT 490 W	-90 ... 220	0.10	Water	5.4	4.40 <sup>2</sup>	4.40 <sup>2</sup>	4.40 <sup>2</sup>	4.40 <sup>2</sup>	4.40 <sup>2</sup>	4.40 <sup>2</sup>	4.40 <sup>2</sup>	4.40 <sup>2</sup>	4.00 <sup>2</sup>	3.30 <sup>2</sup>	2.30 <sup>2</sup>	1.35 <sup>2</sup>	0.70 <sup>1</sup>	0.20 <sup>1</sup>	
XT 1590 WS	-90 ... 220	0.30	Water	8.0	15.00 <sup>2</sup>	15.00 <sup>2</sup>	15.00 <sup>2</sup>	13.00 <sup>2</sup>	10.50 <sup>2</sup>	9.20 <sup>2</sup>	8.50 <sup>2</sup>	8.50 <sup>2</sup>	7.00 <sup>2</sup>	5.30 <sup>2</sup>	3.70 <sup>2</sup>	1.80 <sup>2</sup>	0.90 <sup>1</sup>	0.35 <sup>1</sup>	
XT 4 H	80 ... 320	0.05	-	3.6	-	-	-	-	-	-	-	-	-	-	-	-	-	-	
XT 4 HW	30 ... 320	0.10	Water	3.6	16.00 <sup>2</sup>	9.00 <sup>2</sup>	-	-	-	-	-	-	-	-	-	-	-	-	
XT 8 H	80 ... 320	0.05	-	8.0	-	-	-	-	-	-	-	-	-	-	-	-	-	-	
XT 8 HW	30 ... 320	0.10	Water	8.0	16.00 <sup>2</sup>	9.00 <sup>2</sup>	-	-	-	-	-	-	-	-	-	-	-	-	
<b>LAUDA Variocool / Page 80</b>																			
VC 1200	-20 ... 80	0.05	Air	1.5	-	-	1.20	1.00	0.70	0.40	0.18	-	-	-	-	-	-	-	
VC 1200	-20 ... 80	0.05	Air	2.3	-	-	1.20	1.00	0.70	0.40	0.18	-	-	-	-	-	-	-	
VC 1200	-20 ... 80	0.05	Air	1.5	-	-	1.12	1.00	0.70	0.40	0.18	-	-	-	-	-	-	-	
VC 1200	-20 ... 80	0.05	Air	2.3	-	-	1.12	1.00	0.70	0.40	0.18	-	-	-	-	-	-	-	
VC 1200	-20 ... 80	0.05	Air	1.5	-	-	1.00	1.00	0.70	0.40	0.18	-	-	-	-	-	-	-	
VC 1200	-20 ... 80	0.05	Air	2.3	-	-	1.00	1.00	0.70	0.40	0.18	-	-	-	-	-	-	-	

<sup>1</sup>Pump output step 2 <sup>2</sup>Pump output step 4 <sup>3</sup>Pump output step 8

Pump pressure max. bar	Pump flow max. pressure L/min	Pump connection thread mm	Bath volume min. L	Bath volume max. L	Dimensions (W x D x H) mm	Protection Rating	Noise level dB(A)	Weight kg	Loading max. kW	Power supply V; Hz	Cat. No.	Device type
2.9	45	M30×1.5	2.6	8.1	335×550×660	IP 21C	-	87.0	3.7	230 V; 50 Hz	L001855	XT 150
2.9	45	M30×1.5	2.6	8.1	335×550×660	IP 21C	-	90.0	3.7	230 V; 50 Hz	L001856	XT 250 W
2.9	45	M30×1.5	5.0	11.7	460×550×1285	IP 21C	-	150.0	3.7	230 V; 50 Hz	L001857	XT 350 W
2.9	45	M30×1.5	5.0	11.7	460×550×1285	IP 21C	-	150.0	8.2	400 V; 3/PE; 50 Hz	L001868	XT 550
2.9	45	M30×1.5	5.0	11.7	460×550×1285	IP 21C	-	155.0	8.2	400 V; 3/PE; 50 Hz	L001875	XT 550 W
2.9	45	M30×1.5	5.0	11.7	460×550×1285	IP 21C	-	155.0	9.0	400 V; 3/PE; 50 Hz	L001869	XT 750
2.9	45	M30×1.5	5.0	11.7	460×550×1285	IP 21C	-	155.0	9.7	400 V; 3/PE; 50 Hz	L001870	XT 750 S
2.9	45	M30×1.5	5.0	11.7	460×550×1285	IP 21C	-	160.0	9.0	400 V; 3/PE; 50 Hz	L001876	XT 950 W
2.9	45	M30×1.5	5.0	11.7	460×550×1285	IP 21C	-	160.0	9.7	400 V; 3/PE; 50 Hz	L001877	XT 950 WS
5.8	90	M38×1.5	9.0	26.4	700×550×1600	IP 21C	-	250.0	13.9	400 V; 3/PE; 50 Hz	L001878	XT 1850 W
5.8	90	M38×1.5	9.0	26.4	700×550×1600	IP 21C	-	250.0	17.4	400 V; 3/PE; 50 Hz	L001879	XT 1850 WS
2.9	45	M30×1.5	5.0	11.7	460×550×1285	IP 21C	-	180.0	7.7	400 V; 3/PE; 50 Hz	L001867	XT 280
2.9	45	M30×1.5	5.0	11.7	460×550×1285	IP 21C	-	180.0	7.7	400 V; 3/PE; 50 Hz	L001873	XT 280 W
2.9	45	M30×1.5	9.5	26.9	700×550×1600	IP 21C	-	245.0	9.7	400 V; 3/PE; 50 Hz	L001874	XT 490 W
2.9	45	M30×1.5	10.5	27.9	700×550×1600	IP 21C	-	280.0	13.9	400 V; 3/PE; 50 Hz	L001880	XT 1590 WS
2.9	45	M30×1.5	2.6	8.1	335×550×660	IP 21C	51	60.0	3.7	230 V; 50 Hz	L001839	XT 4 H
2.9	45	M30×1.5	2.6	8.1	335×550×660	IP 21C	51	64.0	3.7	230 V; 50 Hz	L001840	XT 4 HW
2.9	45	M30×1.5	2.6	8.1	335×550×660	IP 21C	51	62.0	8.7	400 V; 3/PE; 50 Hz	L001845	XT 8 H
2.9	45	M30×1.5	2.6	8.1	335×550×660	IP 21C	51	66.0	8.7	400 V; 3/PE; 50 Hz	L001846	XT 8 HW
0.9	28	G 3/4	8.0	15.0	450×550×650	IP 32	51	54.0	2.6	230 V; 50 Hz	L000711	VC 1200
0.9	28	G 3/4	8.0	15.0	450×550×650	IP 32	51	54.0	3.3	230 V; 50 Hz	L000712	VC 1200
3.2	37	G 3/4	8.0	15.0	450×550×790	IP 32	51	54.0	2.6	230 V; 50 Hz	L000921	VC 1200
3.2	37	G 3/4	8.0	15.0	450×550×790	IP 32	51	54.0	3.3	230 V; 50 Hz	L000923	VC 1200
4.8	37	G 3/4	8.0	15.0	450×550×790	IP 32	51	54.0	2.6	230 V; 50 Hz	L000922	VC 1200
4.8	37	G 3/4	8.0	15.0	450×550×790	IP 32	51	54.0	3.3	230 V; 50 Hz	L000924	VC 1200

# LAUDA Circulation and process thermostats

Technical data according to DIN 12876 standard

Device type	Working temperature range °C	Temperature stability ±K	Heat discharge cooling unit	Heater power max. kW	Cooling output kW														
					200 °C	100 °C	20 °C	10 °C	0 °C	-10 °C	-20 °C	-30 °C	-40 °C	-50 °C	-60 °C	-70 °C	-80 °C	-90 °C	
LAUDA Variocool / Page 80																			
VC 1200 W	-20...80	0.05	Water	1.5	-	-	1.20	1.00	0.70	0.40	0.18	-	-	-	-	-	-	-	-
VC 1200 W	-20...80	0.05	Water	2.3	-	-	1.20	1.00	0.70	0.40	0.18	-	-	-	-	-	-	-	-
VC 1200 W	-20...80	0.05	Water	1.5	-	-	1.12	1.00	0.70	0.40	0.18	-	-	-	-	-	-	-	-
VC 1200 W	-20...80	0.05	Water	2.3	-	-	1.12	1.00	0.70	0.40	0.18	-	-	-	-	-	-	-	-
VC 1200 W	-20...80	0.05	Water	2.3	-	-	1.00	1.00	0.70	0.40	0.18	-	-	-	-	-	-	-	-
VC 1200 W	-20...80	0.05	Water	1.5	-	-	1.00	1.00	0.70	0.40	0.18	-	-	-	-	-	-	-	-
VC 2000	-20...80	0.05	Air	1.5	-	-	2.00	1.50	1.06	0.68	0.38	-	-	-	-	-	-	-	-
VC 2000	-20...80	0.05	Air	2.2	-	-	2.00	1.50	1.06	0.68	0.38	-	-	-	-	-	-	-	-
VC 2000	-20...80	0.05	Air	2.2	-	-	1.92	1.50	1.06	0.68	0.38	-	-	-	-	-	-	-	-
VC 2000	-20...80	0.05	Air	1.5	-	-	1.92	1.50	1.06	0.68	0.38	-	-	-	-	-	-	-	-
VC 2000	-20...80	0.05	Air	1.5	-	-	1.80	1.50	1.06	0.68	0.38	-	-	-	-	-	-	-	-
VC 2000	-20...80	0.05	Air	2.2	-	-	1.80	1.50	1.06	0.68	0.38	-	-	-	-	-	-	-	-
VC 2000 W	-20...80	0.05	Water	2.2	-	-	2.00	1.50	1.06	0.68	0.38	-	-	-	-	-	-	-	-
VC 2000 W	-20...80	0.05	Water	1.5	-	-	2.00	1.50	1.06	0.68	0.38	-	-	-	-	-	-	-	-
VC 2000 W	-20...80	0.05	Water	2.2	-	-	1.92	1.50	1.06	0.68	0.38	-	-	-	-	-	-	-	-
VC 2000 W	-20...80	0.05	Water	1.5	-	-	1.92	1.50	1.06	0.68	0.38	-	-	-	-	-	-	-	-
VC 2000 W	-20...80	0.05	Water	2.2	-	-	1.80	1.50	1.06	0.68	0.38	-	-	-	-	-	-	-	-
VC 2000 W	-20...80	0.05	Water	1.5	-	-	1.80	1.50	1.06	0.68	0.38	-	-	-	-	-	-	-	-
VC 3000	-20...80	0.05	Air	1.5	-	-	3.00	2.40	1.68	1.03	0.60	-	-	-	-	-	-	-	-
VC 3000	-20...80	0.05	Air	1.5	-	-	2.80	2.40	1.68	1.03	0.60	-	-	-	-	-	-	-	-
VC 3000 W	-20...80	0.05	Water	1.5	-	-	3.00	2.40	1.68	1.03	0.60	-	-	-	-	-	-	-	-
VC 3000 W	-20...80	0.05	Water	1.5	-	-	2.80	2.40	1.68	1.03	0.60	-	-	-	-	-	-	-	-
VC 5000	-20...80	0.05	Air	4.5	-	-	5.00	3.90	2.75	1.70	1.00	-	-	-	-	-	-	-	-
VC 5000	-20...80	0.05	Air	4.5	-	-	4.50	3.90	2.75	1.70	1.00	-	-	-	-	-	-	-	-
VC 5000	-20...80	0.05	Air	4.5	-	-	4.65	3.90	2.75	1.70	1.00	-	-	-	-	-	-	-	-
VC 5000 W	-20...80	0.05	Water	4.5	-	-	5.00	3.90	2.75	1.70	1.00	-	-	-	-	-	-	-	-
VC 5000 W	-20...80	0.05	Water	4.5	-	-	4.50	3.90	2.75	1.70	1.00	-	-	-	-	-	-	-	-
VC 5000 W	-20...80	0.05	Water	4.5	-	-	4.65	3.90	2.75	1.70	1.00	-	-	-	-	-	-	-	-
VC 7000	-20...80	0.10	Air	4.5	-	-	7.00	5.30	3.70	2.40	1.50	-	-	-	-	-	-	-	-
VC 7000	-20...80	0.10	Air	4.5	-	-	6.50	5.30	3.70	2.40	1.50	-	-	-	-	-	-	-	-
VC 7000	-20...80	0.10	Air	4.5	-	-	6.65	5.30	3.70	2.40	1.50	-	-	-	-	-	-	-	-
VC 7000 W	-20...80	0.10	Water	4.5	-	-	7.00	5.30	3.70	2.40	1.50	-	-	-	-	-	-	-	-
VC 7000 W	-20...80	0.10	Water	4.5	-	-	6.50	5.30	3.70	2.40	1.50	-	-	-	-	-	-	-	-

<sup>1</sup>Pump output step 2 <sup>2</sup>Pump output step 4 <sup>3</sup>Pump output step 8

Pump pressure max. bar	Pump flow max. pressure L/min	Pump connection thread mm	Bath volume min. L	Bath volume max. L	Dimensions (W x D x H) mm	Protection Rating	Noise level dB (A)	Weight kg	Loading max. kW	Power supply V; Hz	Cat. No.	Device type
0.9	28	G 3/4	8.0	15.0	450×550×650	IP 32	50	51.0	2.6	230 V; 50 Hz	L000731	VC 1200 W
0.9	28	G 3/4	8.0	15.0	450×550×650	IP 32	50	51.0	3.3	230 V; 50 Hz	L000732	VC 1200 W
3.2	37	G 3/4	8.0	15.0	450×550×790	IP 32	50	51.0	2.6	230 V; 50 Hz	L000954	VC 1200 W
3.2	37	G 3/4	8.0	15.0	450×550×790	IP 32	50	51.0	3.3	230 V; 50 Hz	L000956	VC 1200 W
4.8	37	G 3/4	8.0	15.0	450×550×790	IP 32	50	51.0	3.3	230 V; 50 Hz	L000957	VC 1200 W
4.8	37	G 3/4	8.0	15.0	450×550×790	IP 32	50	51.0	2.6	230 V; 50 Hz	L000955	VC 1200 W
0.9	28	G 3/4	8.0	15.0	450×550×650	IP 32	52	57.0	2.6	230 V; 50 Hz	L000713	VC 2000
0.9	28	G 3/4	8.0	15.0	450×550×650	IP 32	52	57.0	3.3	230 V; 50 Hz	L000714	VC 2000
3.2	37	G 3/4	8.0	15.0	450×550×790	IP 32	52	57.0	3.3	230 V; 50 Hz	L000927	VC 2000
3.2	37	G 3/4	8.0	15.0	450×550×790	IP 32	52	57.0	2.6	230 V; 50 Hz	L000925	VC 2000
4.8	37	G 3/4	8.0	15.0	450×550×790	IP 32	52	57.0	2.6	230 V; 50 Hz	L000926	VC 2000
4.8	37	G 3/4	8.0	15.0	450×550×790	IP 32	52	57.0	3.3	230 V; 50 Hz	L000928	VC 2000
0.9	28	G 3/4	8.0	15.0	450×550×650	IP 32	50	54.0	3.3	230 V; 50 Hz	L000734	VC 2000 W
0.9	28	G 3/4	8.0	15.0	450×550×650	IP 32	50	54.0	2.6	230 V; 50 Hz	L000733	VC 2000 W
3.2	37	G 3/4	8.0	15.0	450×550×790	IP 32	50	54.0	3.3	230 V; 50 Hz	L000960	VC 2000 W
3.2	37	G 3/4	8.0	15.0	450×550×790	IP 32	50	54.0	2.6	230 V; 50 Hz	L000958	VC 2000 W
4.8	37	G 3/4	8.0	15.0	450×550×790	IP 32	50	54.0	3.3	230 V; 50 Hz	L000961	VC 2000 W
4.8	37	G 3/4	8.0	15.0	450×550×790	IP 32	50	54.0	2.6	230 V; 50 Hz	L000959	VC 2000 W
3.2	37	G 3/4	20.0	33.0	550×650×970	IP 32	57	93.0	2.6	230 V; 50 Hz	L000715	VC 3000
4.8	37	G 3/4	20.0	33.0	550×650×970	IP 32	57	93.0	2.6	230 V; 50 Hz	L000929	VC 3000
3.2	37	G 3/4	20.0	33.0	550×650×970	IP 32	55	89.0	2.6	230 V; 50 Hz	L000735	VC 3000 W
4.8	37	G 3/4	20.0	33.0	550×650×970	IP 32	55	89.0	2.6	230 V; 50 Hz	L000962	VC 3000 W
3.2	37	G 3/4	20.0	33.0	550×650×970	IP 32	65	98.0	7.8	400 V; 3/N/PE; 50 Hz	L000728	VC 5000
4.8	37	G 3/4	20.0	33.0	550×650×970	IP 32	65	98.0	7.8	400 V; 3/N/PE; 50 Hz	L000948	VC 5000
5.0	60	G 3/4	20.0	33.0	550×650×970	IP 32	65	98.0	7.8	400 V; 3/N/PE; 50 Hz	L000949	VC 5000
3.2	37	G 3/4	20.0	33.0	550×650×970	IP 32	64	94.0	7.8	400 V; 3/N/PE; 50 Hz	L000746	VC 5000 W
4.8	37	G 3/4	20.0	33.0	550×650×970	IP 32	64	94.0	7.8	400 V; 3/N/PE; 50 Hz	L000981	VC 5000 W
5.0	60	G 3/4	20.0	33.0	550×650×970	IP 32	64	94.0	7.8	400 V; 3/N/PE; 50 Hz	L001995	VC 5000 W
3.2	37	G 1 1/4	48.0	64.0	650×670×1250	IP 32	66	138.0	8.8	400 V; 3/N/PE; 50 Hz	L000729	VC 7000
4.8	37	G 1 1/4	48.0	64.0	650×670×1250	IP 32	66	138.0	8.8	400 V; 3/N/PE; 50 Hz	L000950	VC 7000
5.0	60	G 1 1/4	48.0	64.0	650×670×1250	IP 32	66	138.0	8.8	400 V; 3/N/PE; 50 Hz	L000951	VC 7000
3.2	37	G 1 1/4	48.0	64.0	650×670×1250	IP 32	60	131.0	8.8	400 V; 3/N/PE; 50 Hz	L000747	VC 7000 W
4.8	37	G 1 1/4	48.0	64.0	650×670×1250	IP 32	60	131.0	8.8	400 V; 3/N/PE; 50 Hz	L000982	VC 7000 W

# LAUDA Circulation and process thermostats

Technical data according to DIN 12876 standard

Device type	Working temperature range °C	Temperature stability ±K	Heat discharge cooling unit	Heater power max. kW	Cooling output kW														
					200 °C	100 °C	20 °C	10 °C	0 °C	-10 °C	-20 °C	-30 °C	-40 °C	-50 °C	-60 °C	-70 °C	-80 °C	-90 °C	
<b>LAUDA Variocool / Page 80</b>																			
VC 7000 W	-20...80	0.10	Water	4.5	-	-	6.65	5.30	3.70	2.40	1.50	-	-	-	-	-	-	-	-
VC 10000	-20...80	0.10	Air	7.5	-	-	10.00	7.60	5.30	3.50	2.00	-	-	-	-	-	-	-	-
VC 10000	-20...80	0.10	Air	7.5	-	-	9.50	7.60	5.30	3.50	2.00	-	-	-	-	-	-	-	-
VC 10000	-20...80	0.10	Air	7.5	-	-	9.65	7.60	5.30	3.50	2.00	-	-	-	-	-	-	-	-
VC 10000 W	-20...80	0.10	Water	7.5	-	-	10.00	7.60	5.30	3.50	2.00	-	-	-	-	-	-	-	-
VC 10000 W	-20...80	0.10	Water	7.5	-	-	9.50	7.60	5.30	3.50	2.00	-	-	-	-	-	-	-	-
VC 10000 W	-20...80	0.10	Water	7.5	-	-	9.65	7.60	5.30	3.50	2.00	-	-	-	-	-	-	-	-
<b>LAUDA Kryoheater Selecta / Page 82</b>																			
KHS 3560 W	-60...200	0.50	Water	18.0	35.00	-	35.00	32.00	30.00	29.00	18.00	14.00	10.00	6.00	2.50	-	-	-	-
KHS 2190 W	-90...200	0.50	Water	18.0	21.00	-	21.00	20.00	18.00	15.00	11.00	10.50	10.00	9.50	9.00	6.30	3.50	1.00	-
<b>LAUDA-Noah POU / Page 84</b>																			
POU 3300	-20...90	0.10	Water	-	-	-	1.20	0.95	0.70	0.45	0.20	-	-	-	-	-	-	-	-
POU 3500	-20...90	0.10	Water	-	-	-	2.40	2.00	1.50	1.00	0.50	-	-	-	-	-	-	-	-
POU 2400	-20...90	0.10	Water	-	-	-	2.45	1.93	1.40	0.88	0.35	-	-	-	-	-	-	-	-

<sup>1</sup>Pump output step 2 <sup>2</sup>Pump output step 4 <sup>3</sup>Pump output step 8



Pump pressure max. bar	Pump flow max. pressure L/min	Pump connection thread mm	Bath volume min. L	Bath volume max. L	Dimensions (W x D x H) mm	Protection Rating	Noise level dB (A)	Weight kg	Loading max. kW	Power supply V; Hz	Cat. No.	Device type
5.0	60	G 1 1/4	48.0	64.0	650×670×1250	IP 32	60	131.0	8.8	400 V; 3/N/PE; 50 Hz	L000983	VC 7000 W
3.2	37	G 1 1/4	48.0	64.0	650×670×1250	IP 32	67	147.0	11.1	400 V; 3/N/PE; 50 Hz	L000730	VC 10000
4.8	37	G 1 1/4	48.0	64.0	650×670×1250	IP 32	67	147.0	11.1	400 V; 3/N/PE; 50 Hz	L000952	VC 10000
5.0	60	G 1 1/4	48.0	64.0	650×670×1250	IP 32	67	147.0	11.1	400 V; 3/N/PE; 50 Hz	L000953	VC 10000
3.2	37	G 1 1/4	48.0	64.0	650×670×1250	IP 32	61	140.0	11.1	400 V; 3/N/PE; 50 Hz	L000748	VC 10000 W
4.8	37	G 1 1/4	48.0	64.0	650×670×1250	IP 32	61	140.0	11.1	400 V; 3/N/PE; 50 Hz	L000984	VC 10000 W
5.0	60	G 1 1/4	48.0	64.0	650×670×1250	IP 32	61	140.0	11.1	400 V; 3/N/PE; 50 Hz	L000985	VC 10000 W
5.5	85	DN 25	15.0	55.0	920×1200×1700	IP 54	68	850.0	29.5	400 V; 3/PE; 50 Hz	L001984	KHS 3560 W
5.5	85	DN 25	15.0	55.0	920×1200×1700	IP 54	68	890.0	32.8	400 V; 3/PE; 50 Hz	L001989	KHS 2190 W
2.8	22	1/2"	1.25	1.25	116×300×560	-	-	25	-	-	-	POU 3300
2.8	27	1/2"	2.5	2.5	194×300×560	-	-	38	-	-	-	POU 3500
2.8	22	1/2"	1.25	1.6	116×300×560	-	-	25	-	-	-	POU 2400

# LAUDA Circulation and process thermostats

## Power supply variants

Device type	Power supply V; Hz	Heater power max. kW	Pump pressure max. bar	Pump flow max. pressure L./min	Loading max. kW	Plug code*	Cat. No.	Device type	Power supply V; Hz	Heater power max. kW	Pump pressure max. bar	Pump flow max. pressure L./min	Loading max. kW	Plug code*	Cat. No.
<b>LAUDA PRO / Page 74</b>															
P 2 E	100-120 V; 50/60 Hz	1.3	0.7	22	1.5	4	L000549	RP 245 E	100 V; 50/60 Hz	1.3	0.7	22	1.5	14	L000533
P 2 EC	100-120 V; 50/60 Hz	1.3	0.7	22	1.5	4	L000553	RP 245 E	120 V; 60 Hz	1.8	0.7	22	1.9	4	L000453
RP 240 E	100 V; 50/60 Hz	1.3	0.7	22	1.6	32	L000540	RP 245 E	120 V; 60 Hz	1.8	0.7	22	1.9	32	L000461
RP 240 E	100 V; 50/60 Hz	1.3	0.7	22	1.5	14	L000532	RP 245 E	200 V; 50/60 Hz	1.9	0.7	22	3.2	32	L000521
RP 240 E	120 V; 60 Hz	1.8	0.7	22	1.9	32	L000460	RP 245 E	200 V; 50/60 Hz	1.9	0.7	22	3.2	3	L000489
RP 240 E	120 V; 60 Hz	1.8	0.7	22	1.9	4	L000452	RP 245 E	200 V; 50/60 Hz	1.9	0.7	22	3.2	31	L000505
RP 240 E	200 V; 50/60 Hz	1.9	0.7	22	3.2	31	L000504	RP 245 E	208-220 V; 60 Hz	2.3	0.7	22	3.5	3	L000313
RP 240 E	200 V; 50/60 Hz	1.9	0.7	22	3.2	3	L000488	RP 245 E	208-220 V; 60 Hz	2.3	0.7	22	3.5	32	L000441
RP 240 E	200 V; 50/60 Hz	1.9	0.7	22	3.2	32	L000520	RP 245 E	208-220 V; 60 Hz	2.3	0.7	22	3.5	31	L000425
RP 240 E	208-220 V; 60 Hz	2.3	0.7	22	3.5	32	L000440	RP 245 EC	100 V; 50/60 Hz	1.3	0.7	22	1.6	32	L000545
RP 240 E	208-220 V; 60 Hz	2.3	0.7	22	3.5	31	L000424	RP 245 EC	100 V; 50/60 Hz	1.3	0.7	22	1.5	14	L000537
RP 240 E	208-220 V; 60 Hz	2.3	0.7	22	3.5	3	L000312	RP 245 EC	120 V; 60 Hz	1.8	0.7	22	1.9	32	L000465
RP 240 EC	100 V; 50/60 Hz	1.3	0.7	22	1.6	32	L000544	RP 245 EC	120 V; 60 Hz	1.8	0.7	22	1.9	4	L000457
RP 240 EC	100 V; 50/60 Hz	1.3	0.7	22	1.5	14	L000536	RP 245 EC	200 V; 50/60 Hz	1.9	0.7	22	3.2	31	L000513
RP 240 EC	120 V; 60 Hz	1.8	0.7	22	1.9	4	L000456	RP 245 EC	200 V; 50/60 Hz	1.9	0.7	22	3.2	3	L000497
RP 240 EC	120 V; 60 Hz	1.8	0.7	22	1.9	32	L000464	RP 245 EC	200 V; 50/60 Hz	1.9	0.7	22	3.2	32	L000529
RP 240 EC	200 V; 50/60 Hz	1.9	0.7	22	3.2	31	L000512	RP 245 EC	208-220 V; 60 Hz	2.3	0.7	22	3.5	31	L000433
RP 240 EC	200 V; 50/60 Hz	1.9	0.7	22	3.2	3	L000496	RP 245 EC	208-220 V; 60 Hz	2.3	0.7	22	3.5	32	L000449
RP 240 EC	200 V; 50/60 Hz	1.9	0.7	22	3.2	32	L000528	RP 245 EC	208-220 V; 60 Hz	2.3	0.7	22	3.5	3	L000321
RP 240 EC	208-220 V; 60 Hz	2.3	0.7	22	3.5	32	L000448	RP 250 E	200 V; 50/60 Hz	1.9	0.7	22	3.2	3	L002498
RP 240 EC	208-220 V; 60 Hz	2.3	0.7	22	3.5	31	L000432	RP 250 EC	200 V; 50/60 Hz	1.9	0.7	22	3.2	3	L002499
RP 240 EC	208-220 V; 60 Hz	2.3	0.7	22	3.5	3	L000320	RP 290 E	200 V; 50/60 Hz	1.9	0.7	22	3.2	3	L002506
RP 245 E	100 V; 50/60 Hz	1.3	0.7	22	1.6	32	L000541	RP 290 EC	200 V; 50/60 Hz	1.9	0.7	22	3.2	3	L002507
<b>LAUDA Integral T / Page 76</b>															
T 4600	208 V; 3/PE; 60 Hz	4.9	3.2	40	8.5	15	L001728	T 7000	440-480 V; 3/PE; 60 Hz	5.3	6.0	60	11.5	22	L001738
T 4600	208 V; 3/PE; 60 Hz	4.9	5.5	40	8.5	15	L001827	T 7000 W	440-480 V; 3/PE; 60 Hz	5.3	6.0	60	11.2	22	L001739
T 4600 W	208 V; 3/PE; 60 Hz	4.9	3.2	40	8.3	15	L001729	T 10000	440-480 V; 3/PE; 60 Hz	8.0	6.0	60	15.0	22	L001740
T 4600 W	208 V; 3/PE; 60 Hz	4.9	5.5	40	8.3	15	L001828	T 10000 W	440-480 V; 3/PE; 60 Hz	8.0	6.0	60	14.5	22	L001741

\*All data for the plug codes can be found on page 150

Device type	Power supply V; Hz	Heater power max. kW	Pump pressure max. bar	Pump flow max. pressure L /min	Loading max. kW	Plug code*	Cat. No.	Device type	Power supply V; Hz	Heater power max. kW	Pump pressure max. bar	Pump flow max. pressure L /min	Loading max. kW	Plug code*	Cat. No.
<b>LAUDA Integral XT / Page 78</b>															
XT 150	200 V; 50/60 Hz	2.7	2.9	45	3.2	3	L001893	XT 280	200 V; 3/PE; 50/60 Hz	2.7	2.9	45	6.5	31	L001897
XT 150	208-220 V; 60 Hz	3.2	2.9	45	3.6	3	L001881	XT 280	208-220 V; 3/PE; 60 Hz	3.2	2.9	45	7.0	31	L001885
XT 250 W	200 V; 50/60 Hz	2.7	2.9	45	3.2	3	L001894	XT 280 W	200 V; 3/PE; 50/60 Hz	2.7	2.9	45	6.5	31	L001901
XT 250 W	208-220 V; 60 Hz	3.2	2.9	45	3.6	3	L001882	XT 280 W	208-220 V; 3/PE; 60 Hz	3.2	2.9	45	7.0	31	L001889
XT 350 W	200 V; 50/60 Hz	2.7	2.9	45	3.2	3	L001895	XT 490 W	200 V; 3/PE; 50/60 Hz	5.4	2.9	45	8.7	31	L001902
XT 350 W	208-220 V; 60 Hz	3.2	2.9	45	3.6	3	L001883	XT 490 W	208-220 V; 3/PE; 60 Hz	6.5	2.9	45	9.6	31	L001890
XT 550	200 V; 3/PE; 50/60 Hz	5.4	2.9	45	7.0	31	L001898	XT 1590 W	400 V; 3/PE; 50 Hz & 440-480 V; 3/PE; 60 Hz	7.8	2.9	45	16.6	22	L001908
XT 550	208-220 V; 3/PE; 60 Hz	6.5	2.9	45	7.7	31	L001886	XT 1590 W	440-480 V; 3/PE; 60 Hz	7.8	2.9	45	16.6	22	L001906
XT 550 W	200 V; 3/PE; 50/60 Hz	5.4	2.9	45	7.0	31	L001903	XT 4 H	200 V; 50/60 Hz	2.7	2.9	45	3.2	3	L001851
XT 550 W	208-220 V; 3/PE; 60 Hz	6.5	2.9	45	7.7	31	L001891	XT 4 H	208-220 V; 60 Hz	3.2	2.9	45	3.6	3	L001847
XT 750	200 V; 3/PE; 50/60 Hz	5.4	2.9	45	7.0	31	L001899	XT 4 HW	200 V; 50/60 Hz	2.7	2.9	45	3.2	3	L001852
XT 750	208-220 V; 3/PE; 60 Hz	6.5	2.9	45	7.7	31	L001887	XT 4 HW	208-220 V; 60 Hz	3.2	2.9	45	3.6	3	L001848
XT 950 W	200 V; 3/PE; 50/60 Hz	5.4	2.9	45	7.0	31	L001904	XT 8 H	200 V; 3/PE; 50/60 Hz	8.0	2.9	45	8.7	31	L001853
XT 950 W	208-220 V; 3/PE; 60 Hz	6.5	2.9	45	7.7	31	L001892	XT 8 H	208-220 V; 3/PE; 60 Hz	8.0	2.9	45	8.7	31	L001849
XT 1850 W	400 V; 3/PE; 50 Hz & 440-480 V; 3/PE; 60 Hz	15.6	5.8	90	20.8	22	L001907	XT 8 HW	200 V; 3/PE; 50/60 Hz	8.0	2.9	45	8.7	31	L001854
XT 1850 W	440-480 V; 3/PE; 60 Hz	15.6	5.8	90	20.8	22	L001905	XT 8 HW	208-220 V; 3/PE; 60 Hz	8.0	2.9	45	8.7	31	L001850

# LAUDA Circulation and process thermostats

## Power supply variants

Device type	Power supply V; Hz	Heater power max. kW	Pump pressure max. bar	Pump flow max. pressure L./min	Loading max. kW	Plug code*	Cat. No.	Device type	Power supply V; Hz	Heater power max. kW	Pump pressure max. bar	Pump flow max. pressure L./min	Loading max. kW	Plug code*	Cat. No.
LAUDA Variocool / Page 80															
VC 1200	200 V; 50/60 Hz	1.1	0.9	28	2.3	3	L000768	VC 2000	208-220 V; 60 Hz	2.1	3.2	37	3.2	3	L000992
VC 1200	200 V; 50/60 Hz	1.7	0.9	28	2.9	3	L000769	VC 2000	208-220 V; 60 Hz	1.3	3.2	37	2.5	3	L000990
VC 1200	200 V; 50/60 Hz	1.7	3.2	37	2.9	3	L001018	VC 2000	208-220 V; 60 Hz	2.1	4.8	37	3.2	3	L000993
VC 1200	200 V; 50/60 Hz	1.1	3.2	37	2.3	3	L001016	VC 2000	208-220 V; 60 Hz	1.3	4.8	37	2.5	3	L000991
VC 1200	200 V; 50/60 Hz	1.7	4.8	37	2.9	3	L001019	VC 2000 W	200 V; 50/60 Hz	1.0	0.9	28	2.3	3	L000778
VC 1200	200 V; 50/60 Hz	1.1	4.8	37	2.3	3	L001017	VC 2000 W	200 V; 50/60 Hz	1.7	0.9	28	2.9	3	L000779
VC 1200	208-220 V; 60 Hz	1.3	0.9	28	2.4	3	L000751	VC 2000 W	200 V; 50/60 Hz	1.1	3.2	37	2.3	3	L001035
VC 1200	208-220 V; 60 Hz	2.1	0.9	28	3.1	3	L000752	VC 2000 W	200 V; 50/60 Hz	1.7	3.2	37	2.9	3	L001037
VC 1200	208-220 V; 60 Hz	1.3	3.2	37	2.4	3	L000986	VC 2000 W	200 V; 50/60 Hz	1.1	4.8	37	2.3	3	L001036
VC 1200	208-220 V; 60 Hz	2.1	3.2	37	3.1	3	L000988	VC 2000 W	200 V; 50/60 Hz	1.7	4.8	37	2.9	3	L001038
VC 1200	208-220 V; 60 Hz	2.1	4.8	37	3.1	3	L000989	VC 2000 W	208-220 V; 60 Hz	1.3	0.9	28	2.5	3	L000761
VC 1200	208-220 V; 60 Hz	1.3	4.8	37	2.4	3	L000987	VC 2000 W	208-220 V; 60 Hz	2.1	0.9	28	3.2	3	L000762
VC 1200 W	200 V; 50/60 Hz	1.0	0.9	28	2.3	3	L000776	VC 2000 W	208-220 V; 60 Hz	1.3	3.2	37	2.5	3	L001006
VC 1200 W	200 V; 50/60 Hz	1.7	0.9	28	2.9	3	L000777	VC 2000 W	208-220 V; 60 Hz	2.1	3.2	37	3.2	3	L001008
VC 1200 W	200 V; 50/60 Hz	1.1	3.2	37	2.3	3	L001031	VC 2000 W	208-220 V; 60 Hz	1.3	4.8	37	2.5	3	L001005
VC 1200 W	200 V; 50/60 Hz	1.7	3.2	37	2.9	3	L001033	VC 2000 W	208-220 V; 60 Hz	2.1	4.8	37	3.2	3	L001007
VC 1200 W	200 V; 50/60 Hz	1.1	4.8	37	2.3	3	L001032	VC 3000	200 V; 50/60 Hz	1.0	3.2	37	2.6	3	L000772
VC 1200 W	200 V; 50/60 Hz	1.7	4.8	37	2.9	3	L001034	VC 3000	200 V; 50/60 Hz	1.1	4.8	37	2.6	3	L001024
VC 1200 W	208-220 V; 60 Hz	2.1	0.9	28	3.1	3	L000760	VC 3000	208-220 V; 60 Hz	1.3	3.2	37	2.8	3	L000755
VC 1200 W	208-220 V; 60 Hz	1.3	0.9	28	2.4	3	L000759	VC 3000	208-220 V; 60 Hz	1.3	4.8	37	2.8	3	L000994
VC 1200 W	208-220 V; 60 Hz	2.1	3.2	37	3.1	3	L001003	VC 3000 W	200 V; 50/60 Hz	1.0	3.2	37	2.6	3	L000780
VC 1200 W	208-220 V; 60 Hz	1.3	3.2	37	2.4	3	L001001	VC 3000 W	200 V; 50/60 Hz	1.1	4.8	37	2.6	3	L001039
VC 1200 W	208-220 V; 60 Hz	1.3	4.8	37	2.4	3	L001002	VC 3000 W	208-220 V; 60 Hz	1.3	3.2	37	2.8	3	L000763
VC 1200 W	208-220 V; 60 Hz	2.1	4.8	37	3.1	3	L001004	VC 3000 W	208-220 V; 60 Hz	1.3	4.8	37	2.8	3	L001009
VC 2000	200 V; 50/60 Hz	1.7	0.9	28	2.9	3	L000771	VC 5000	200 V; 3/PE; 50/60 Hz	3.4	3.2	37	4.3	31	L000773
VC 2000	200 V; 50/60 Hz	1.0	0.9	28	2.3	3	L000770	VC 5000	200 V; 3/PE; 50/60 Hz	3.4	4.8	37	4.3	31	L001025
VC 2000	200 V; 50/60 Hz	1.7	3.2	37	2.9	3	L001022	VC 5000	200 V; 3/PE; 50/60 Hz	3.4	4.3	60	4.3	31	L001026
VC 2000	200 V; 50/60 Hz	1.1	3.2	37	2.3	3	L001020	VC 5000	208-220 V; 3/PE; 60 Hz	4.1	3.2	37	4.5	31	L000756
VC 2000	200 V; 50/60 Hz	1.1	4.8	37	2.3	3	L001021	VC 5000	208-220 V; 3/PE; 60 Hz	4.1	4.8	37	4.5	31	L000995
VC 2000	200 V; 50/60 Hz	1.7	4.8	37	2.9	3	L001023	VC 5000	208-220 V; 3/PE; 60 Hz	4.1	5.0	60	4.5	31	L000996
VC 2000	208-220 V; 60 Hz	1.3	0.9	28	2.5	3	L000753	VC 5000 W	200 V; 3/PE; 50/60 Hz	3.4	3.2	37	4.3	31	L000781
VC 2000	208-220 V; 60 Hz	2.1	0.9	28	3.2	3	L000754	VC 5000 W	200 V; 3/PE; 50/60 Hz	3.4	4.8	37	4.3	31	L001040

\*All data for the plug codes can be found on page 150

Device type	Power supply V; Hz	Heater power max. kW	Pump pressure max. bar	Pump flow max. pressure L./min	Loading max. kW	Plug code*	Cat. No.	Device type	Power supply V; Hz	Heater power max. kW	Pump pressure max. bar	Pump flow max. pressure L./min	Loading max. kW	Plug code*	Cat. No.
VC 5000 W	200 V; 3/PE; 50/60 Hz	3.4	4.3	60	4.3	31	L001041	VC 7000 W	208-220 V; 3/PE; 60 Hz	4.1	4.8	37	5.7	31	L001012
VC 5000 W	208-220 V; 3/PE; 60 Hz	4.1	3.2	37	4.5	31	L000764	VC 7000 W	208-220 V; 3/PE; 60 Hz	4.1	5.0	60	5.7	31	L001013
VC 5000 W	208-220 V; 3/PE; 60 Hz	4.1	4.8	37	4.5	31	L001010	VC 10000	200 V; 3/PE; 50/60 Hz	5.7	3.2	37	7.6	31	L000775
VC 5000 W	208-220 V; 3/PE; 60 Hz	4.1	5.0	60	4.5	31	L001011	VC 10000	200 V; 3/PE; 50/60 Hz	5.7	4.8	37	7.6	31	L001029
VC 7000	200 V; 3/PE; 50/60 Hz	3.4	3.2	37	5.4	31	L000774	VC 10000	200 V; 3/PE; 50/60 Hz	5.7	4.3	60	7.6	31	L001030
VC 7000	200 V; 3/PE; 50/60 Hz	3.4	4.8	37	5.4	31	L001027	VC 10000	208-220 V; 3/PE; 60 Hz	6.9	3.2	37	7.7	31	L000758
VC 7000	200 V; 3/PE; 50/60 Hz	3.4	4.3	60	5.4	31	L001028	VC 10000	208-220 V; 3/PE; 60 Hz	6.9	4.8	37	7.7	31	L000999
VC 7000	208-220 V; 3/PE; 60 Hz	4.1	3.2	37	5.7	31	L000757	VC 10000	208-220 V; 3/PE; 60 Hz	6.9	5.0	60	7.7	31	L001000
VC 7000	208-220 V; 3/PE; 60 Hz	4.1	4.8	37	5.7	31	L000997	VC 10000 W	200 V; 3/PE; 50/60 Hz	5.7	3.2	37	7.6	31	L000783
VC 7000	208-220 V; 3/PE; 60 Hz	4.1	5.0	60	5.7	31	L000998	VC 10000 W	200 V; 3/PE; 50/60 Hz	5.7	4.8	37	7.6	31	L001044
VC 7000 W	200 V; 3/PE; 50/60 Hz	3.4	3.2	37	5.4	31	L000782	VC 10000 W	200 V; 3/PE; 50/60 Hz	5.7	4.3	60	7.6	31	L001045
VC 7000 W	200 V; 3/PE; 50/60 Hz	3.4	4.8	37	5.4	31	L001042	VC 10000 W	208-220 V; 3/PE; 60 Hz	6.9	3.2	37	7.7	31	L000766
VC 7000 W	200 V; 3/PE; 50/60 Hz	3.4	4.3	60	5.4	31	L001043	VC 10000 W	208-220 V; 3/PE; 60 Hz	6.9	4.8	37	7.7	31	L001014
VC 7000 W	208-220 V; 3/PE; 60 Hz	4.1	3.2	37	5.7	31	L000765	VC 10000 W	208-220 V; 3/PE; 60 Hz	6.9	5.0	60	7.7	31	L001015

LAUDA Variocool / Page 80

# LAUDA Circulation and process thermostats

## More characteristics

LAUDA PRO / Page 74

### Effective cooling power kW

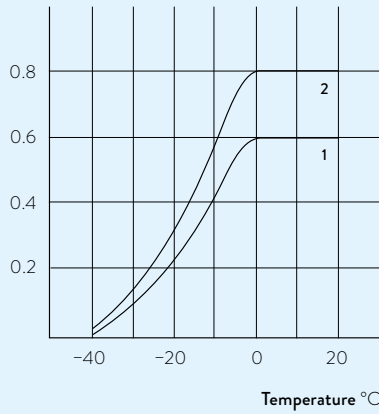

- 1 RP 240 E (C)
- 2 RP 245 E (C)

LAUDA Integral T / Page 76

### HEATING PERFORMANCE Heat transfer liquid: Kryo 30

#### Bath temperature °C

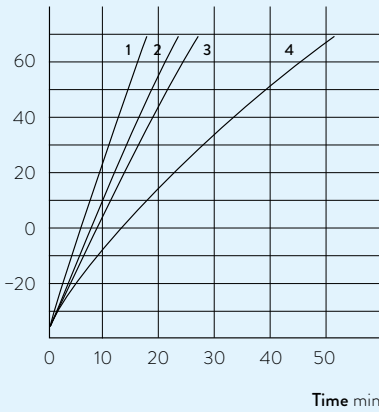

- 1 T 10000  
T 10000 W
- 2 T 4600  
T 4600 W
- 3 T 7000  
T 7000 W
- 4 T 2200  
T 2200 W

### COOLING POWER According to DIN 12876

#### Effective cooling power kW

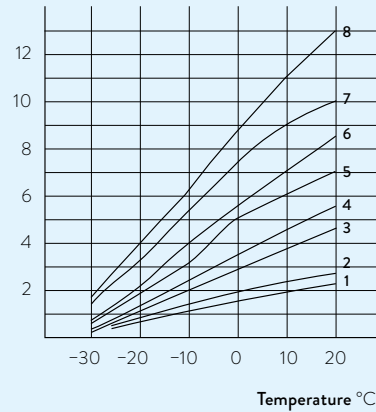

- 1 T 2200
- 2 T 2200 W
- 3 T 4600
- 4 T 4600 W
- 5 T 7000
- 6 T 7000 W
- 7 T 10000
- 8 T 10000 W

LAUDA Integral XT / Page 78

### PUMP CHARACTERISTIC Water

#### Pressure bar

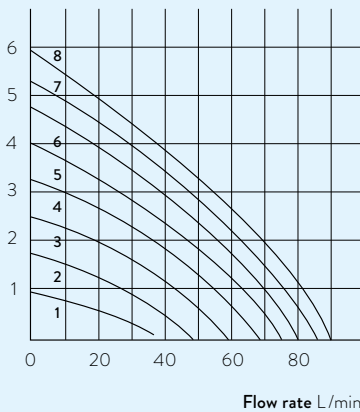

- 1 Step 1
- 2 Step 2
- 3 Step 3
- 4 Step 4
- 5 Step 5
- 6 Step 6
- 7 Step 7
- 8 Step 8

### COOLING POWER According to DIN 12876

#### Effective cooling power kW

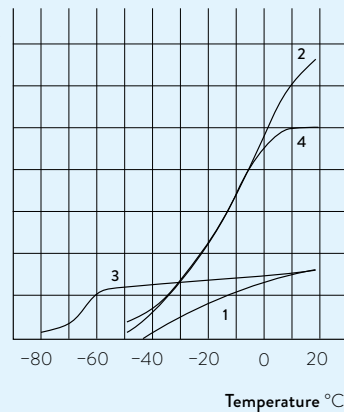

- 1 XT 150
- 2 XT 750  
XT 750 H  
XT 750 S  
XT 750 HS
- 3 XT 280
- 4 XT 550

Effective cooling power kW

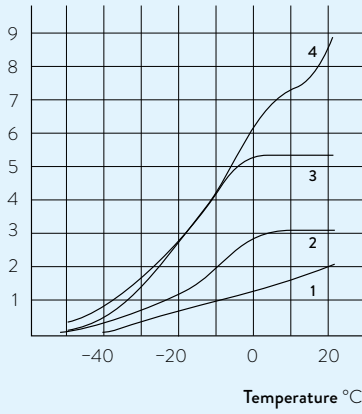

- 1 XT 250 W
- 2 XT 350 W  
XT 350 HW
- 3 XT 550 W
- 4 XT 950 W  
XT 950 WS

Effective cooling power kW

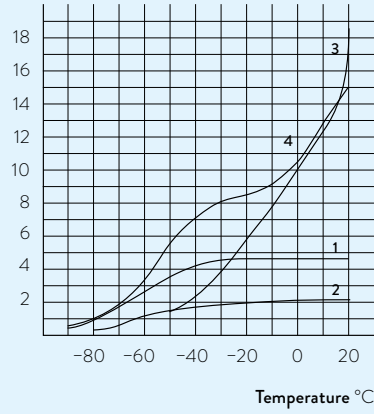

- 1 XT 490 W
- 2 XT 280 W
- 3 XT 1850 W  
XT 1850 WS
- 4 XT 1590 WS

COOLING POWER Heat transfer liquid: Ultra 350

Effective cooling power kW

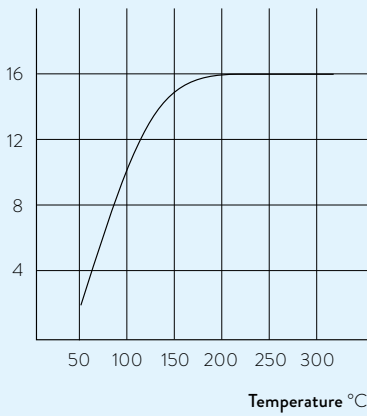

- 1 XT 4 HW
- 2 XT 8 HW

# LAUDA Circulation and process thermostats

## More characteristics

LAUDA Variocool / Page 80 and Page 110

**PUMP CHARACTERISTIC** Water

Pressure bar

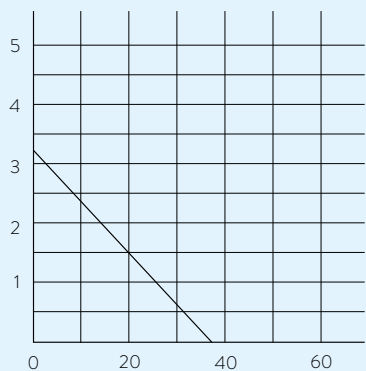

3.2 bar, 37 L/min

**PUMP CHARACTERISTIC** Water

Pressure bar

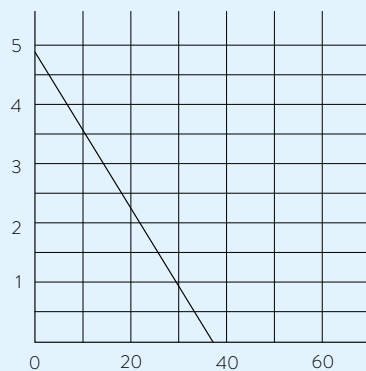

4.8 bar, 37 L/min

**PUMP CHARACTERISTIC** Water

Pressure bar

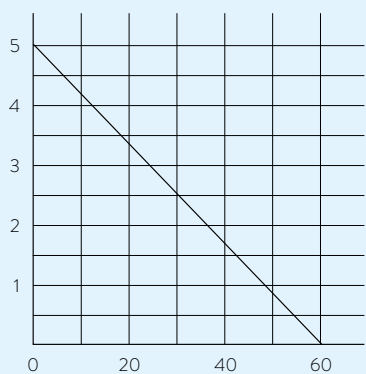

5.0 bar, 60 L/min



**PUMP CHARACTERISTIC** Water

Pressure bar

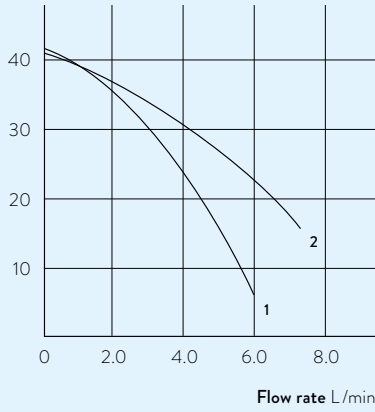

- 1 POU 3300
- 2 POU 2400, POU 3500

# LAUDA

## CIRCULATION CHILLERS

### Specific application examples

---

- Rotary evaporators
- Distillation systems
- Spectrometers
- Supply of cooling traps
- Digital printing
- Laser cutting
- Laser sorting
- Point welding
- Injection molding
- Tunnel drilling machines
- Centralized cooling water supply



LABOR

14.8

PROTECTOR

# LAUDA Microcool

Circulation chillers for reliable continuous operation in laboratory and research applications from  $-10$  to  $40^{\circ}\text{C}$

$-10^{\circ}\text{C}$    $40^{\circ}\text{C}$

## Compact circulation chillers with outstanding price-performance ratio

The LAUDA Microcool line of user-friendly circulation chillers consists of four compact models with large LED display and membrane keypad, offering cooling capacities of 0.25 to 1.2 kW. The highlight of these devices is the premium quality centrifugal pump with magnetic coupling – unique to this price category: Magnetic coupling of pump and electric motor prevents any kind of seal issue from arising on the pump shaft, eliminating the chance for any fluid to leak.



Illuminated viewing glass enables quick identification of the fill level



Standard-issue RS 232 interface and alarm contact

## PUMP CHARACTERISTICS Water

Pressure bar

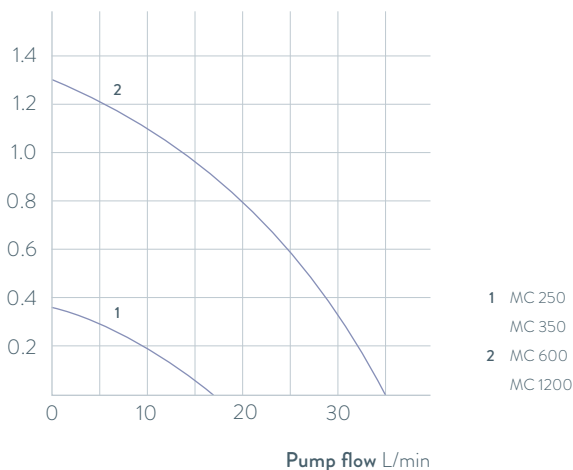

## Important functions

- Auto-start timer and auto shutdown function
- Filling opening at the top, drain connection at the rear
- Cooling capacity adapted via solenoid valve control, including automatic compressor control

## Included accessories

Nipples, screw caps

## Further accessories

Tubing

All technical data and power supply variants can be found in the ›Technical data‹ section.

More at [www.lauda.de/1764](http://www.lauda.de/1764)



### LAUDA Microcool

The compact circulation chiller MC250 and MC350 fit effortlessly on a lab bench. Somewhat larger models are also available having 600 and 1200 watts of cooling capacity and which can be positioned on the floor under a lab bench to save space.



# LAUDA Variocool

Circulation chillers up to 10 kW from  $-20$  to  $40$  °C for dissipating heat in laboratories, mini plants and production sites

-20°C  40°C

## Comprehensive spectrum of services for demanding temperature control tasks

The LAUDA Variocool circulation chillers impress with their space-saving construction and versatility provided by a wide variety of options. They are simple and convenient to operate via the color TFT display. Other interfaces can be retrofitted to supplement the standard USB interface and alarm contact. Positioned in the front of the device they allow easy access. The working pressure and flow rate can be adapted to the respective requirements in different applications using an integrated bypass and optional pumps to achieve optimum temperature control.



Color TFT display and membrane keypad offer simple and easy adjustment options



Standard-issue USB interface and alarm contact as well as additional optional interfaces that can be retrofitted

## PUMP CHARACTERISTIC Water

Pressure bar

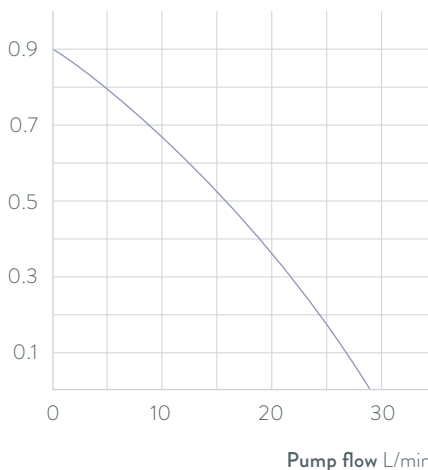

## Important functions

- Adjustable bypass for pressure limitation
- Filling opening at the top, drain tap at the rear
- Integral programmer
- Electronic level indicator and low-level alarm
- SmartCool system for energy-saving digital cooling control including automatic compressor control

## Included accessories

Nipples, screw caps

## Further accessories

Hoses, 2-port and 4-port manifold, ball valves, flow monitors and interface modules

All technical data and power supply variants can be found in the ›Technical data‹ section.

More at [www.lauda.de/1766](http://www.lauda.de/1766)



### LAUDA Variocool

All models are available in air and water-cooled versions (W) and fitted with moveable as well as fixable castors. High-performance circulation chillers in a tower design starting from the VC 5000 model are available with sound insulation or the option of outdoor installation.



# LAUDA Ultracool

Process circulation chillers with cooling capacities of up to 265 kW from  $-5$  to  $25$  °C for industrial applications

$-5$  °C   $25$  °C

## Reliable temperature control and secure operation

Suitable for outdoor installation, the compact LAUDA Ultracool circulation chillers with high cooling capacities are ›Plug & Operate‹ systems with a cold water tank, centrifugal pump and internal bypass. The standard-issue antifreeze protection thermostat prevents freezing of the heat exchanger. Integrated pressure switches also protect the circuit against pressure that is too high or too low and chiller casing made of galvanized steel panels coated with epoxy resin protects against corrosion even in aggressive production environments.



Standard-issue castors for easy positioning at UC Mini



Integrated motor fan speed regulator allows operation in ambient conditions up to  $-15$  °C and reduces the noise level

## PUMP CHARACTERISTIC Standard pumps (3 bar), 50 Hz

Pressure bar

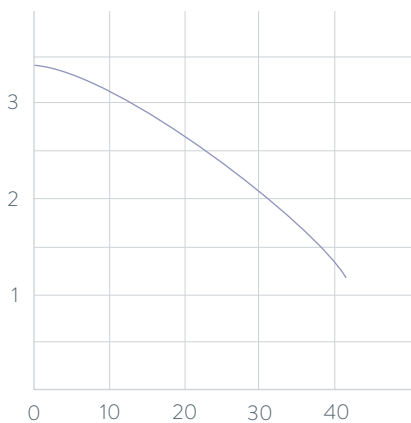

UC 2  
UC 4

Pump flow L/min

## Important functions

- Premium quality centrifugal pumps, internal bypass
- Water circuit consisting of flexible industrial hoses
- Release valve for draining the circuit

## Included accessories

Internal bypass, antifreeze protection thermostat

## Further accessories

Tube kits, return valve

All technical data and power supply variants can be found in the ›Technical data‹ section.

More at [www.lauda.de/1768](http://www.lauda.de/1768)





### LAUDA Ultracool

The UC Mini circulation chillers UC 2 and UC 4 have a cooling capacity up to 4.9 kW. In addition to being more compact, the geometry of the devices guarantees easy access to components requiring regular maintenance. Standard-issue integrated fan control make it possible to operate the UC Midi circulation chiller with low-noise centrifugal pumps and internal bypass for automatic adjustment of water flow at ambient temperatures of  $-15^{\circ}\text{C}$  to  $50^{\circ}\text{C}$ . The Ultracool Maxi circulation chillers have cooling capacities up to 265 kW and are suitable for outdoor installation.



# LAUDA Circulation chillers

## Device type overview

LAUDA Microcool / Page 108



LAUDA Variocool / Page 110



LAUDA Ultracool / Page 112



# LAUDA Circulation chillers

## Interfaces

	Pt 100	USB	Ethernet	RS 232 / 485	Analog	Namur contact	Sub-D contact	Profibus	EtherCat M8	EtherCat RJ 45	Modbus	Malfunction contact	Number of module slots, large	Number of module slots, small
LAUDA Microcool / Page 108	-	-	-	RS 232	-	-	-	-	-	-	-	S	-	-
LAUDA Variocool / Page 110	Z	S	Z	Z	Z	Z	Z	Z	Z	Z	-	S	1	1
LAUDA Ultracool / Page 112	-	-	-	-	-	-	-	-	-	-	OD	-	-	-

S = Series standard

Z = Available as an accessory

OD = optional (cannot be retrofitted)



LRZ 912  
Analog module



LRZ 913  
RS 232/485  
interface



LRZ 914  
Contact module with single input  
and single output (NAMUR)



LRZ 915  
Contact module with  
3 inputs and 3 outputs



LRZ 917  
Profibus module



LRZ 918  
Pt100/Li bus  
module



LRZ 921  
Ethernet module



LRZ 922  
EtherCAT module  
with M8 connection



LRZ 923  
EtherCAT module  
with RJ45 connection

# LAUDA Circulation chillers

## Function overview

Operating element	Microcool	Variocool	Ultracool
Display	7-Segment	TFT	LCD mono
Mode of operation	3-button	Cursor softkey	3-button softkey
1-point calibration	✓	✓	-
Programmer, programs/segments	-	5 / 150	-
Programmer, tolerance range function	-	✓	-
Graphic temperature profile display	-	✓	-
Pump pressure display (analog)	- / ✓	✓	✓
Pump pressure display (digital)	-	-	-
Adjustable bypass	-	✓	✓
Level indicator (analog)	✓	-	-
Level indicator (digital)	-	✓	-
Standby timer	✓	✓	✓
Flow control instrument	-	Z	-
Overflow	✓	-	-
Low-level alarm	✓	✓	✓
Drain tap	-	✓	✓
Drain screw	✓	-	-



# LAUDA Circulation chillers

Technical data according to DIN 12876 standard

Device type	Working temperature range °C	Temperature stability ±K	Ambient temperature range °C	Heat removal cooling unit	Heater power max. kW	Cooling output kW					Pump pressure max. bar	Pump flow max. pressure L/min	Pump connection thread mm	Bath volume min. L
						20 °C	10 °C	0 °C	-10 °C	-20 °C				
<b>LAUDA Microcool / Page 108</b>														
MC 250	-10...40	0.50	5...40	Air	-	0.25	0.20	0.15	0.09	-	0.4	16	Ø 10	2.0
MC 350	-10...40	0.50	5...40	Air	-	0.35	0.27	0.20	0.12	-	0.4	16	Ø 10	4.0
MC 600	-10...40	0.50	5...40	Air	-	0.60	0.50	0.36	0.15	-	1.3	35	G 3/4	4.0
MC 1200	-10...40	0.50	5...40	Air	-	1.20	1.05	0.75	0.40	-	1.3	35	G 3/4	7.0
<b>LAUDA Variocool / Page 110</b>														
VC 1200	-20...40	0.05	5...40	Air	-	1.20	1.00	0.70	0.40	0.18	0.9	28	G 3/4	8.0
VC 1200	-20...40	0.05	5...40	Air	-	1.12	1.00	0.70	0.40	0.18	3.2	37	G 3/4	8.0
VC 1200	-20...40	0.05	5...40	Air	-	1.00	1.00	0.70	0.40	0.18	4.8	37	G 3/4	8.0
VC 1200 W	-20...40	0.05	5...40	Water	-	1.20	1.00	0.70	0.40	0.18	0.9	28	G 3/4	8.0
VC 1200 W	-20...40	0.05	5...40	Water	-	1.12	1.00	0.70	0.40	0.18	3.2	37	G 3/4	8.0
VC 1200 W	-20...40	0.05	5...40	Water	-	1.00	1.00	0.70	0.40	0.18	4.8	37	G 3/4	8.0
VC 2000	-20...40	0.05	5...40	Air	-	2.00	1.50	1.06	0.68	0.38	0.9	28	G 3/4	8.0
VC 2000	-20...40	0.05	5...40	Air	-	1.92	1.50	1.06	0.68	0.38	3.2	37	G 3/4	8.0
VC 2000	-20...40	0.05	5...40	Air	-	1.80	1.50	1.06	0.68	0.38	4.8	37	G 3/4	8.0
VC 2000 W	-20...40	0.05	5...40	Water	-	2.00	1.50	1.06	0.68	0.38	0.9	28	G 3/4	8.0
VC 2000 W	-20...40	0.05	5...40	Water	-	1.92	1.50	1.06	0.68	0.38	3.2	37	G 3/4	8.0
VC 2000 W	-20...40	0.05	5...40	Water	-	1.80	1.50	1.06	0.68	0.38	4.8	37	G 3/4	8.0
VC 3000	-20...40	0.05	5...40	Air	-	3.00	2.40	1.68	1.03	0.60	3.2	37	G 3/4	20.0
VC 3000	-20...40	0.05	5...40	Air	-	2.80	2.40	1.68	1.03	0.60	4.8	37	G 3/4	20.0
VC 3000 W	-20...40	0.05	5...40	Water	-	3.00	2.40	1.68	1.03	0.60	3.2	37	G 3/4	20.0
VC 3000 W	-20...40	0.05	5...40	Water	-	2.80	2.40	1.68	1.03	0.60	4.8	37	G 3/4	20.0
VC 5000	-20...40	0.05	5...40	Air	-	5.00	3.90	2.75	1.70	1.00	3.2	37	G 3/4	20.0
VC 5000	-20...40	0.05	5...40	Air	-	4.50	3.90	2.75	1.70	1.00	4.8	37	G 3/4	20.0
VC 5000	-20...40	0.05	5...40	Air	-	4.65	3.90	2.75	1.70	1.00	5.0	60	G 3/4	20.0
VC 5000 W	-20...40	0.05	5...40	Water	-	5.00	3.90	2.75	1.70	1.00	3.2	37	G 3/4	20.0
VC 5000 W	-20...40	0.05	5...40	Water	-	4.50	3.90	2.75	1.70	1.00	4.8	37	G 3/4	20.0
VC 5000 W	-20...40	0.05	5...40	Water	-	4.65	3.90	2.75	1.70	1.00	5.0	60	G 3/4	20.0
VC 7000	-20...40	0.10	5...40	Air	-	7.00	5.30	3.70	2.40	1.50	3.2	37	G 1 1/4	48.0
VC 7000	-20...40	0.10	5...40	Air	-	6.50	5.30	3.70	2.40	1.50	4.8	37	G 1 1/4	48.0
VC 7000	-20...40	0.10	5...40	Air	-	6.65	5.30	3.70	2.40	1.50	5.0	60	G 1 1/4	48.0

Bath volume max. L	Dimensions (W x D x H) mm	Protection Rating	Noise level dB (A)	Weight kg	Loading max. kW	Power supply V; Hz	Cat. No.	Device type
4.0	200×350×465	IP 32	60	26.0	0.2	230 V; 50 Hz	L001046	MC 250
7.0	240×400×500	IP 32	60	35.0	0.5	230 V; 50 Hz	L001047	MC 350
8.0	350×480×595	IP 32	57	51.0	0.7	230 V; 50 Hz	L001048	MC 600
14.0	450×550×650	IP 32	59	64.0	1.2	230 V; 50 Hz	L001049	MC 1200
15.0	450×550×650	IP 32	51	54.0	1.1	230 V; 50 Hz	L000657	VC 1200
15.0	450×550×790	IP 32	51	54.0	1.1	230 V; 50 Hz	L000784	VC 1200
15.0	450×550×790	IP 32	51	54.0	1.1	230 V; 50 Hz	L000785	VC 1200
15.0	450×550×650	IP 32	50	51.0	1.1	230 V; 50 Hz	L000671	VC 1200 W
15.0	450×550×790	IP 32	50	51.0	1.1	230 V; 50 Hz	L000805	VC 1200 W
15.0	450×550×790	IP 32	50	51.0	1.1	230 V; 50 Hz	L000806	VC 1200 W
15.0	450×550×650	IP 32	52	57.0	1.6	230 V; 50 Hz	L000658	VC 2000
15.0	450×550×790	IP 32	52	57.0	1.6	230 V; 50 Hz	L000786	VC 2000
15.0	450×550×790	IP 32	52	57.0	1.6	230 V; 50 Hz	L000787	VC 2000
15.0	450×550×650	IP 32	50	54.0	1.6	230 V; 50 Hz	L000672	VC 2000 W
15.0	450×550×790	IP 32	50	54.0	1.6	230 V; 50 Hz	L000807	VC 2000 W
15.0	450×550×790	IP 32	50	54.0	1.6	230 V; 50 Hz	L000808	VC 2000 W
33.0	550×650×970	IP 32	57	93.0	1.8	230 V; 50 Hz	L000659	VC 3000
33.0	550×650×970	IP 32	57	93.0	1.8	230 V; 50 Hz	L000788	VC 3000
33.0	550×650×970	IP 32	55	89.0	1.8	230 V; 50 Hz	L000673	VC 3000 W
33.0	550×650×970	IP 32	55	89.0	1.8	230 V; 50 Hz	L000809	VC 3000 W
33.0	550×650×970	IP 32	65	98.0	3.3	400 V; 3/N/PE; 50 Hz	L000668	VC 5000
33.0	550×650×970	IP 32	65	98.0	3.3	400 V; 3/N/PE; 50 Hz	L000799	VC 5000
33.0	550×650×970	IP 32	65	98.0	3.3	400 V; 3/N/PE; 50 Hz	L000802	VC 5000
33.0	550×650×970	IP 32	64	94.0	3.3	400 V; 3/N/PE; 50 Hz	L000680	VC 5000 W
33.0	550×650×970	IP 32	64	94.0	3.3	400 V; 3/N/PE; 50 Hz	L000820	VC 5000 W
33.0	550×650×970	IP 32	64	94.0	3.3	400 V; 3/N/PE; 50 Hz	L000823	VC 5000 W
64.0	650×670×1250	IP 32	66	138.0	4.3	400 V; 3/N/PE; 50 Hz	L000669	VC 7000
64.0	650×670×1250	IP 32	66	138.0	4.3	400 V; 3/N/PE; 50 Hz	L000800	VC 7000
64.0	650×670×1250	IP 32	66	138.0	4.3	400 V; 3/N/PE; 50 Hz	L000803	VC 7000

# LAUDA Circulation chillers

Technical data according to DIN 12876 standard

Device type	Working temperature range °C	Temperature stability ±K	Ambient temperature range °C	Heat removal cooling unit	Heater power max. kW	Cooling output kW					Pump pressure max. bar	Pump flow max. pressure L/min	Pump connection thread mm	Bath volume min. L
						20 °C	10 °C	0 °C	-10 °C	-20 °C				
LAUDA Variocool / Page 110														
VC 7000 W	-20...40	0.10	5...40	Water	-	7.00	5.30	3.70	2.40	1.50	3.2	37	G 1 1/4	48.0
VC 7000 W	-20...40	0.10	5...40	Water	-	6.50	5.30	3.70	2.40	1.50	4.8	37	G 1 1/4	48.0
VC 7000 W	-20...40	0.10	5...40	Water	-	6.65	5.30	3.70	2.40	1.50	5.0	60	G 1 1/4	48.0
VC 10000	-20...40	0.10	5...40	Air	-	10.00	7.60	5.30	3.50	2.00	3.2	37	G 1 1/4	48.0
VC 10000	-20...40	0.10	5...40	Air	-	9.50	7.60	5.30	3.50	2.00	4.8	37	G 1 1/4	48.0
VC 10000	-20...40	0.10	5...40	Air	-	9.65	7.60	5.30	3.50	2.00	5.0	60	G 1 1/4	48.0
VC 10000 W	-20...40	0.10	5...40	Water	-	10.00	7.60	5.30	3.50	2.00	3.2	37	G 1 1/4	48.0
VC 10000 W	-20...40	0.10	5...40	Water	-	9.50	7.60	5.30	3.50	2.00	4.8	37	G 1 1/4	48.0
VC 10000 W	-20...40	0.10	5...40	Water	-	9.65	7.60	5.30	3.50	2.00	5.0	60	G 1 1/4	48.0



Bath volume max. L	Dimensions (W x D x H) mm	Protection Rating	Noise level dB (A)	Weight kg	Loading max. kW	Power supply V; Hz	Cat. No.	Device type
64.0	650×670×1250	IP 32	60	131.0	4.3	400 V; 3/N/PE; 50 Hz	L000681	VC 7000 W
64.0	650×670×1250	IP 32	60	131.0	4.3	400 V; 3/N/PE; 50 Hz	L000821	VC 7000 W
64.0	650×670×1250	IP 32	60	131.0	4.3	400 V; 3/N/PE; 50 Hz	L000824	VC 7000 W
64.0	650×670×1250	IP 32	67	147.0	5.4	400 V; 3/N/PE; 50 Hz	L000670	VC 10000
64.0	650×670×1250	IP 32	67	147.0	5.4	400 V; 3/N/PE; 50 Hz	L000801	VC 10000
64.0	650×670×1250	IP 32	67	147.0	5.4	400 V; 3/N/PE; 50 Hz	L000804	VC 10000
64.0	650×670×1250	IP 32	61	140.0	5.4	400 V; 3/N/PE; 50 Hz	L000682	VC 10000 W
64.0	650×670×1250	IP 32	61	140.0	5.4	400 V; 3/N/PE; 50 Hz	L000822	VC 10000 W
64.0	650×670×1250	IP 32	61	140.0	5.4	400 V; 3/N/PE; 50 Hz	L000825	VC 10000 W

# LAUDA Circulation chillers

## Technical data

Device type	Working temperature range °C	Temperature stability ±K	Ambient temperature range °C	Cooling output at water outlet temperature kW							Motor fan			Pump pressure max. bar	
				25 °C	20 °C	15 °C	10 °C	5 °C	0 °C	-5 °C	Number of refrigerant circuits	No.	kW		m <sup>3</sup> /h
LAUDA Ultracool / Page 112															
UC 2	-5...25	2	-15...50	2.80	2.80	2.50	2.10	1.80	1.50	1.20	1	1	0.18	2400	3.4
UC 4	-5...25	2	-15...50	6.90	6.90	5.90	4.90	4.10	3.40	2.80	1	1	0.18	2400	3.4
UC-0060	-5...25	2	-15...50	10.80	10.20	8.60	7.10	5.80	4.70	3.80	1	1	1.04	7000	4.2
UC-0080	-5...25	2	-15...50	15.80	14.70	11.90	9.40	7.30	5.60	4.10	1	1	1.04	7000	4.2
UC-0100	-5...25	2	-15...50	18.60	17.10	14.30	11.40	8.80	6.60	4.80	1	1	1.04	7000	4.2
UC-0140	-5...25	2	-15...50	22.30	20.20	17.10	14.00	11.00	8.40	6.30	1	1	1.04	7000	4.2
UC-0180	-5...25	2	-15...50	32.90	30.20	26.00	22.00	18.00	14.50	11.50	1	1	1.04	9000	4.2
UC-0240	-5...25	2	-15...50	37.30	34.60	30.30	26.30	22.30	18.20	14.50	1	1	1.04	9000	4.2
UC-0300	-5...25	2	-15...45	50.30	48.20	40.90	34.10	28.20	23.10	18.60	1	2	1.20	18000	4.7
UC-0400	-5...25	2	-15...45	62.50	59.70	51.20	43.30	35.10	28.10	22.00	1	2	1.20	18000	4.7
UC-0500	-5...25	2	-15...45	68.40	65.60	56.80	48.70	41.20	33.50	26.80	1	2	1.20	18000	4.7
UC-0650	-5...25	2	-15...45	84.60	84.60	75.20	64.40	53.60	43.90	35.50	1	2	2.50	23000	4.7
UC-0800	-5...25	2	-15...45	114.30	114.30	103.00	87.90	72.30	57.80	45.40	2	4	2.40	36000	4.7
UC-1000	-5...25	2	-15...45	140.80	140.80	126.10	106.40	85.90	67.00	51.20	2	4	2.40	40800	3.7
UC-1350	-5...25	2	-15...45	182.10	182.10	163.70	139.20	113.70	90.00	69.80	2	6	3.60	57000	5.5
UC-1700	-5...25	2	-15...45	228.40	228.40	205.90	175.70	144.60	115.60	90.80	2	6	3.60	55200	5.2
UC-2400	-5...25	2	-15...45	336.90	336.90	308.80	265.00	223.10	182.80	148.20	2	6	7.50	66000	5.2

Correction factor ambient temperature;  $C_{NOM} = C_{WORK} \times F$

Ambient temperature	25	30	35	40	45
Correction factor F	1	0.9	0.85	0.78	0.66

Note: The values calculated with the correction factors are only approximated values

Pump flow max. L/min	Pump pressure nominal bar	Pump flow nominal L/min	Pump connection thread mm	Volume water tank L	Dimensions (W x D x H) mm	Protection Rating	Noise level dB (A)	Weight kg	Loading max. kW	Max. fuse A	Power supply V; Hz	Cat. No.	Device type
42	3.3	5.6	Rp 1/2	19	640×640×635	IP 44	40.0	80	1.4	16	230 V; 50 Hz	E6002411	UC 2
42	2.8	13.8	Rp 1/2	19	640×640×635	IP 44	42.5	85	1.8	16	230 V; 50 Hz	E6004411	UC 4
130	4.0	20.1	HT DN25	100	715×945×1490	IP 54	56.3	165	3.8	20	400 V; 3/PE; 50 Hz	E6006323	UC-0060
130	4.0	26.6	HT DN25	100	715×945×1490	IP 54	60.1	175	4.1	25	400 V; 3/PE; 50 Hz	E6008323	UC-0080
130	3.9	33.6	HT DN25	100	715×945×1490	IP 54	58.5	175	4.6	25	400 V; 3/PE; 50 Hz	E6010323	UC-0100
130	3.7	43.8	HT DN25	100	715×945×1490	IP 54	58.1	180	5.6	25	400 V; 3/PE; 50 Hz	E6014323	UC-0140
130	3.2	62.6	HT DN25	100	715×945×1490	IP 54	56.0	210	6.6	32	400 V; 3/PE; 50 Hz	E6018323	UC-0180
130	2.7	84.1	HT DN25	100	715×945×1490	IP 54	57.5	230	8.0	32	400 V; 3/PE; 50 Hz	E6024323	UC-0240
230	3.9	98.0	HT DN40	200	1005×1565×1965	IP 54	50.2	450	9.4	40	400 V; 3/PE; 50 Hz	E6030323	UC-0300
230	3.6	124.0	HT DN40	200	1005×1565×1965	IP 54	53.5	450	11.4	40	400 V; 3/PE; 50 Hz	E6040323	UC-0400
230	3.3	150.0	HT DN40	200	1005×1565×1965	IP 54	55.3	450	13.6	50	400 V; 3/PE; 50 Hz	E6050323	UC-0500
420	3.7	196.0	HT DN40	300	1005×1565×1965	IP 54	59.2	630	18.5	63	400 V; 3/PE; 50 Hz	E6065323	UC-0650
420	3.4	247.0	Rp 2	300	1545×2230×2010	IP 54	58.3	1020	27.5	80	400 V; 3/PE; 50 Hz	E6080223	UC-0800
500	3.5	299.0	Rp 2 1/2	500	1660×3400×2090	IP 54	63.1	1460	33.4	100	400 V; 3/PE; 50 Hz	E6100221	UC-1000
500	4.5	392.0	Rp 2 1/2	500	1660×3400×2090	IP 54	62.2	1570	43.8	150	400 V; 3/PE; 50 Hz	E6135221	UC-1350
670	3.4	494.0	Rp 2 1/2	500	1660×3400×2090	IP 54	61.3	1630	54.9	150	400 V; 3/PE; 50 Hz	E6170221	UC-1700
970	3.6	733.0	DIN-2566 DN80	500	1660×3585×2090	IP 54	62.7	1690	71.4	200	400 V; 3/PE; 50 Hz	E6240221	UC-2400

# LAUDA Circulation chillers

## Power supply variants

Device type	Power supply V; Hz	Pump pressure max. bar	Pump flow max. pressure L /min	Loading max. kW	Plug code*	Cat. No.	Device type	Power supply V; Hz	Pump pressure max. bar	Pump flow max. pressure L /min	Loading max. kW	Plug code*	Cat. No.
<b>LAUDA Microcool / Page 108</b>													
MC 250	100 V; 50/60 Hz	0.4	16	0.2	14	L001071	MC 600	100 V; 50/60 Hz	1.3	35	0.8	14	L001073
MC 250	115 V; 60 Hz	0.4	16	0.2	14	L001066	MC 600	115 V; 60 Hz	1.3	35	0.8	14	L001068
MC 350	100 V; 50/60 Hz	0.4	16	0.5	14	L001072	MC 1200	100 V; 50/60 Hz	1.3	35	1.1	14	L001074
MC 350	115 V; 60 Hz	0.4	16	0.5	14	L001067	MC 1200	115 V; 60 Hz	1.3	35	1.1	14	L001069
<b>LAUDA Variocool / Page 110</b>													
VC 1200	200 V; 50/60 Hz	0.9	28	1.3	3	L000698	VC 3000	200 V; 50/60 Hz	3.2	37	2.2	3	L000700
VC 1200	200 V; 50/60 Hz	3.2	37	1.3	3	L000848	VC 3000	200 V; 50/60 Hz	4.8	37	2.2	3	L000852
VC 1200	200 V; 50/60 Hz	4.8	37	1.3	3	L000849	VC 3000	208-220 V; 60 Hz	3.2	37	2.3	3	L000687
VC 1200	208-220 V; 60 Hz	0.9	28	1.4	3	L000685	VC 3000	208-220 V; 60 Hz	4.8	37	2.3	3	L000830
VC 1200	208-220 V; 60 Hz	3.2	37	1.4	3	L000826	VC 3000 W	200 V; 50/60 Hz	3.2	37	2.2	3	L000706
VC 1200	208-220 V; 60 Hz	4.8	37	1.4	3	L000827	VC 3000 W	200 V; 50/60 Hz	4.8	37	2.2	3	L000863
VC 1200 W	200 V; 50/60 Hz	0.9	28	1.3	3	L000704	VC 3000 W	208-220 V; 60 Hz	3.2	37	2.3	3	L000693
VC 1200 W	200 V; 50/60 Hz	3.2	37	1.3	3	L000859	VC 3000 W	208-220 V; 60 Hz	4.8	37	2.3	3	L000841
VC 1200 W	200 V; 50/60 Hz	4.8	37	1.3	3	L000860	VC 5000	200 V; 3/PE; 50/60 Hz	3.2	37	3.5	31	L000701
VC 1200 W	208-220 V; 60 Hz	0.9	28	1.4	3	L000691	VC 5000	200 V; 3/PE; 50/60 Hz	4.8	37	3.5	31	L000853
VC 1200 W	208-220 V; 60 Hz	3.2	37	1.4	3	L000837	VC 5000	200 V; 3/PE; 50/60 Hz	4.3	60	3.5	31	L000856
VC 1200 W	208-220 V; 60 Hz	4.8	37	1.4	3	L000838	VC 5000	208-220 V; 3/PE; 60 Hz	3.2	37	3.6	31	L000688
VC 2000	200 V; 50/60 Hz	0.9	28	2.0	3	L000699	VC 5000	208-220 V; 3/PE; 60 Hz	4.8	37	3.6	31	L000831
VC 2000	200 V; 50/60 Hz	3.2	37	2.0	3	L000850	VC 5000	208-220 V; 3/PE; 60 Hz	5.0	60	3.6	31	L000834
VC 2000	200 V; 50/60 Hz	4.8	37	2.0	3	L000851	VC 5000 W	200 V; 3/PE; 50/60 Hz	3.2	37	3.5	31	L000707
VC 2000	208-220 V; 60 Hz	0.9	28	2.2	3	L000686	VC 5000 W	200 V; 3/PE; 50/60 Hz	4.8	37	3.5	31	L000864
VC 2000	208-220 V; 60 Hz	3.2	37	2.2	3	L000829	VC 5000 W	200 V; 3/PE; 50/60 Hz	4.3	60	3.5	31	L000867
VC 2000	208-220 V; 60 Hz	4.8	37	2.2	3	L000828	VC 5000 W	208-220 V; 3/PE; 60 Hz	3.2	37	3.6	31	L000694
VC 2000 W	200 V; 50/60 Hz	0.9	28	2.0	3	L000705	VC 5000 W	208-220 V; 3/PE; 60 Hz	4.8	37	3.6	31	L000842
VC 2000 W	200 V; 50/60 Hz	3.2	37	2.0	3	L000861	VC 5000 W	208-220 V; 3/PE; 60 Hz	5.0	60	3.6	31	L000845
VC 2000 W	200 V; 50/60 Hz	4.8	37	2.0	3	L000862	VC 7000	200 V; 3/PE; 50/60 Hz	3.2	37	4.5	31	L000702
VC 2000 W	208-220 V; 60 Hz	0.9	28	2.2	3	L000692	VC 7000	200 V; 3/PE; 50/60 Hz	4.8	37	4.5	31	L000854
VC 2000 W	208-220 V; 60 Hz	3.2	37	2.2	3	L000840	VC 7000	200 V; 3/PE; 50/60 Hz	4.3	60	4.5	31	L000857
VC 2000 W	208-220 V; 60 Hz	4.8	37	2.2	3	L000839	VC 7000	208-220 V; 3/PE; 60 Hz	3.2	37	4.6	31	L000689

\*All data for the plug codes can be found on page 150

Device type	Power supply V; Hz	Pump pressure max. bar	Pump flow max. pressure L /min	Loading max. kW	Plug code*	Cat. No.	Device type	Power supply V; Hz	Pump pressure max. bar	Pump flow max. pressure L /min	Loading max. kW	Plug code*	Cat. No.
<b>LAUDA Variocool / Page 110</b>													
VC 7000	208-220 V; 3/PE; 60 Hz	4.8	37	4.6	31	L000832	VC 10000	200 V; 3/PE; 50/60 Hz	4.3	60	5.7	31	L000858
VC 7000	208-220 V; 3/PE; 60 Hz	5.0	60	4.6	31	L000835	VC 10000	208-220 V; 3/PE; 60 Hz	3.2	37	5.9	31	L000690
VC 7000 W	200 V; 3/PE; 50/60 Hz	3.2	37	4.5	31	L000708	VC 10000	208-220 V; 3/PE; 60 Hz	4.8	37	5.9	31	L000833
VC 7000 W	200 V; 3/PE; 50/60 Hz	4.8	37	4.5	31	L000865	VC 10000	208-220 V; 3/PE; 60 Hz	5.0	60	5.9	31	L000836
VC 7000 W	200 V; 3/PE; 50/60 Hz	4.3	60	4.5	31	L000868	VC 10000 W	200 V; 3/PE; 50/60 Hz	3.2	37	5.7	31	L000709
VC 7000 W	208-220 V; 3/PE; 60 Hz	3.2	37	4.6	31	L000695	VC 10000 W	200 V; 3/PE; 50/60 Hz	4.8	37	5.7	31	L000866
VC 7000 W	208-220 V; 3/PE; 60 Hz	4.8	37	4.6	31	L000843	VC 10000 W	200 V; 3/PE; 50/60 Hz	4.3	60	5.7	31	L000869
VC 7000 W	208-220 V; 3/PE; 60 Hz	5.0	60	4.6	31	L000846	VC 10000 W	208-220 V; 3/PE; 60 Hz	3.2	37	5.9	31	L000696
VC 10000	200 V; 3/PE; 50/60 Hz	3.2	37	5.7	31	L000703	VC 10000 W	208-220 V; 3/PE; 60 Hz	4.8	37	5.9	31	L000844
VC 10000	200 V; 3/PE; 50/60 Hz	4.8	37	5.7	31	L000855	VC 10000 W	208-220 V; 3/PE; 60 Hz	5.0	60	5.9	31	L000847

**LAUDA Ultracool / Page 112**

UC 2	230 V; 60 Hz	3.5	50	1.4	-	E6002431	UC-0400	460 V; 3/PE; 60 Hz	4.8	300	15.0	-	E6040341
UC 4	230 V; 60 Hz	3.5	50	1.8	-	E6004431	UC-0500	460 V; 3/PE; 60 Hz	4.8	300	18.3	-	E6050341
UC-0060	460 V; 3/PE; 60 Hz	4.1	125	5.0	-	E6006341	UC-0650	460 V; 3/PE; 60 Hz	4.8	300	25.7	-	E6065341
UC-0080	460 V; 3/PE; 60 Hz	4.1	125	4.9	-	E6008341	UC-0800	460 V; 3/PE; 60 Hz	4.8	300	35.4	-	E6080241
UC-0100	460 V; 3/PE; 60 Hz	4.1	125	5.8	-	E6010341	UC-1000	460 V; 3/PE; 60 Hz	5.2	430	42.1	-	E6100241
UC-0140	460 V; 3/PE; 60 Hz	4.1	125	7.0	-	E6014341	UC-1350	460 V; 3/PE; 60 Hz	5.4	600	55.3	-	E6135241
UC-0180	460 V; 3/PE; 60 Hz	4.1	125	8.3	-	E6018341	UC-1700	460 V; 3/PE; 60 Hz	5.4	600	70.2	-	E6170241
UC-0240	460 V; 3/PE; 60 Hz	4.1	125	10.5	-	E6024341	UC-2400	460 V; 3/PE; 60 Hz	3.7	1170	96.1	-	E6240241
UC-0300	460 V; 3/PE; 60 Hz	4.8	300	12.5	-	E6030341							

# LAUDA Circulation chillers

## More characteristics

LAUDA Variocool / Page 80 and Page 110

PUMP CHARACTERISTIC Water

Pressure bar

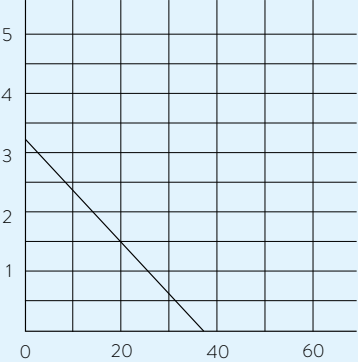

3.2 bar, 37 L/min

PUMP CHARACTERISTIC Water

Pressure bar

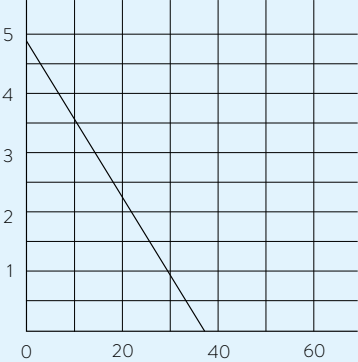

4.8 bar, 37 L/min

PUMP CHARACTERISTIC Water

Pressure bar

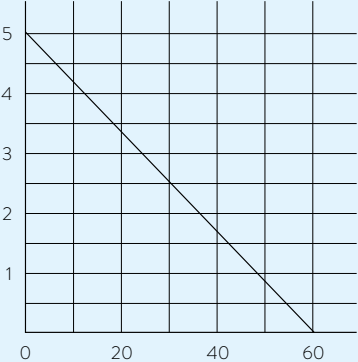

5.0 bar, 60 L/min

**PUMP CHARACTERISTIC** Water

Pressure bar

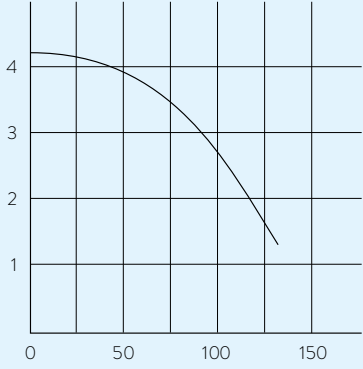

- UC 0060
- UC 0080
- UC 0100
- UC 0140
- UC 0180
- UC 0240

**PUMP CHARACTERISTIC** Water

Pressure bar

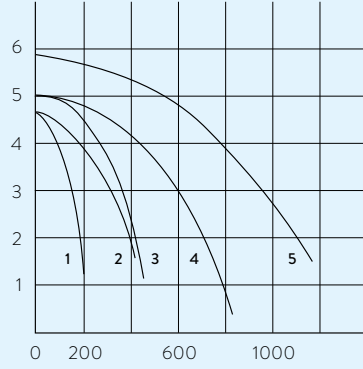

- 1 UC 0300
- UC 0400
- UC 0500
- 2 UC 0650
- UC 0800
- 3 UC 1000
- 4 UC 1350
- UC 1700
- 5 UC 2400

# LAUDA CALIBRATION THERMOSTATS

## Specific application examples

---

- Calibration of thermometers
- Validation of temperature sensors
- Quality testing heat meter





# LAUDA Ecoline

Calibration and adjustment of temperatures from  $-30$  to  $200^{\circ}\text{C}$  with LAUDA calibration thermostats



## High-performance comprehensive solution for calibration and adjustment

LAUDA calibration thermostats provide constant temperature and homogeneity in calibration and adjustment in the test chamber. Depending on the desired size, bath opening and usable depth, different types are available to choose from – each having variable testing chambers, as well as a comprehensive range of products and accessories. The ability of the liquid thermostat to transfer heat through its heat transfer liquid 40 to 60 times better than through air makes it the perfect solution, especially in comparison to heating cabinets and metal block thermostats.

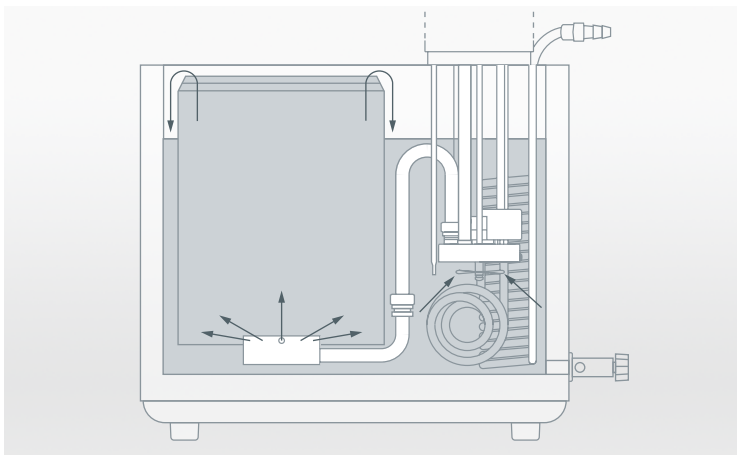

Constant immersion depth thanks to a calibration chamber with overflow principle



Easy handling

## HEATING PERFORMANCE Heat transfer liquid: Ultra 240, bath closed

Bath temperature  $^{\circ}\text{C}$

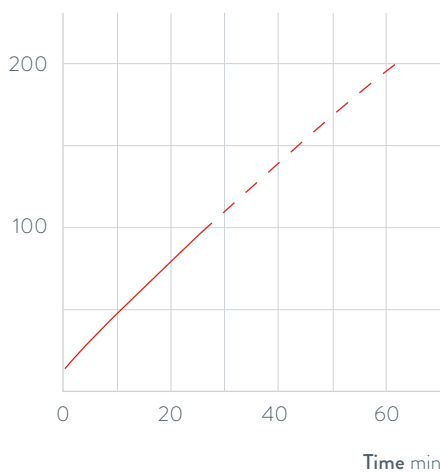

RE 212 J  
RE 312 J

## Important functions

- LAUDA Vario pump with five selectable output levels
- Vertical adjustment of the temperature chamber possible
- Stainless steel bath vessel (insulated, with handles and drain tap)
- RS 232 and RS 485 interfaces and analog inputs and outputs
- Automatic adjustment of cooling output
- Programmer

## Included accessories

Nipples, screw caps, bath cover

## Further accessories

Calibration racks

All technical data and power supply variants can be found in the [Technical data](#) section.

More at [www.lauda.de/1772](http://www.lauda.de/1772)



### LAUDA Ecoline Staredition

Temperature stabilities up to  $\pm 0.01\text{ K}$  at temperatures up to  $-30\text{ °C}$  are achieved with the calibration thermostats of LAUDA Ecoline Staredition. The RE 312J model is sure to impress with its external temperature probe and comes as standard with the PC software LAUDA Wintherm Plus – like the RE 212J model, it also offers digital interfaces and a large, double space display as well as a basic programmer.



# LAUDA Proline

## Calibration and adjustment of temperatures from -40 to 300 °C with LAUDA calibration thermostats



### High-performance comprehensive solution for calibration and adjustment

LAUDA calibration thermostats provide constant temperature and homogeneity in calibration and adjustment in the test chamber. Depending on the desired size, bath opening and usable depth, different types are available to choose from – each having variable testing chambers, as well as a comprehensive range of products and accessories.

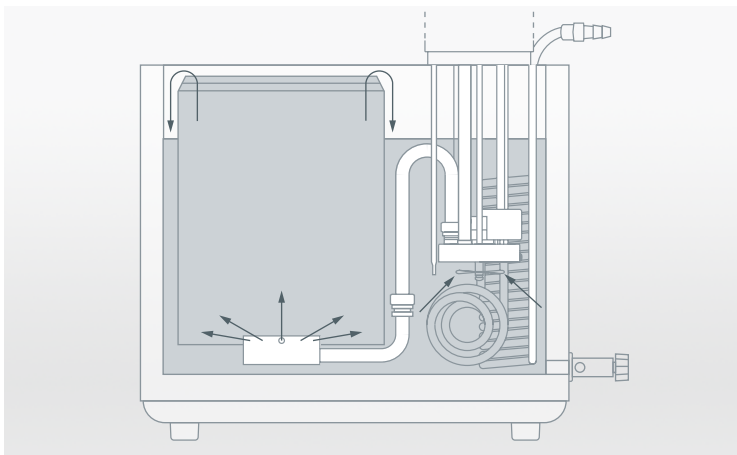

Constant immersion depth thanks to a calibration chamber with overflow principle



Removable remote control for easy and intuitive operation

### HEATING PERFORMANCE Heat transfer liquid: Ultra 240, bath closed

Bath temperature °C

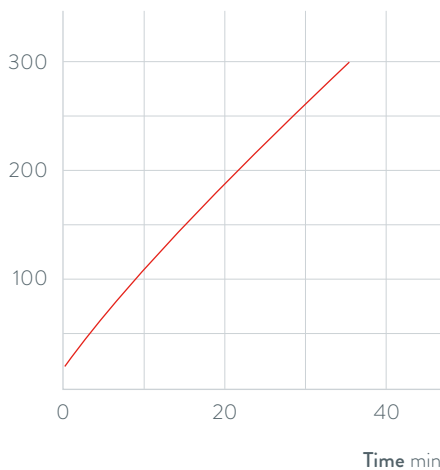

PJ 12/PJ 12 C  
(up to 300 °C)  
PJL 12/PJL 12 C  
(up to 200 °C)

### Important functions

- Stainless steel bath vessel (insulated, with handles and drain tap)
- Selectable Master control head with LED display or detachable Command operating unit with graphic LCD display
- LAUDA Vario Flex pump (pressure pump) with eight selectable output levels
- PowerAdapt system for optimally adapted max. heating output without influencing the mains power supply

### Included accessories

Nipples, screw caps, bath cover

### Further accessories

Calibration racks

All technical data and power supply variants can be found in the »Technical data« section.

More at [www.lauda.de/1774](http://www.lauda.de/1774)



### LAUDA Proline

For maximum temperatures up to 300 °C, the compact models of the LAUDA Proline PJ12 and PJ12 C can be used, which can also be specially operated to -40 °C, together with a LAUDA through-flow cooler.



# LAUDA Calibration thermostats

## Device type overview

LAUDA Ecoline / Page 130

LAUDA Proline / Page 132



602 mm

RE 212 J  
RE 312 J



630 mm

PJ 12 C  
PJL 12 C



574 mm

PJ 12  
PJL 12

# LAUDA Calibration thermostats

## Interfaces

	Pt 100	USB	Ethernet	RS 232 / 485	Analog	Namur contact	Sub-D contact	Profibus	EtherCat M8	EtherCat RJ 45	Malfunction contact	Number of module slots, large	Number of module slots, small
LAUDA Ecoline RE 212 J / Page 130	-	-	-	S	-	-	-	-	-	-	S	-	-
LAUDA Ecoline RE 312 J / Page 130	S	-	-	S	S	-	-	-	-	-	S	-	-
LAUDA Proline Master / Page 132	S	-	Z	Z	Z	Z	Z	Z	Z	Z	-	2	-
LAUDA Proline Command / Page 132	S	-	Z	S	Z	Z	Z	Z	Z	Z	-	2	-

S = Series standard

Z = Available as an accessory



LRZ 912  
Analog module



LRZ 913  
RS 232/485  
interface



LRZ 914  
Contact module with single input  
and single output (NAMUR)



LRZ 915  
Contact module with  
3 inputs and 3 outputs



LRZ 917  
Profibus module



LRZ 918  
Pt100/Li bus  
module



LRZ 921  
Ethernet module



LRZ 922  
EtherCAT module  
with M8 connection



LRZ 923  
EtherCAT module  
with RJ45 connection

# LAUDA Calibration thermostats

Technical data according to DIN 12876 standard

Device type	Working temperature range °C	Operating temperature range °C	Temperature stability ±K	Safety fittings	Heater power max. kW	Cooling output kW					Pump type	Pump pressure max. bar	Pump suction max. bar	Pump flow max. pressure L/min	Pump flow max. Sog L/min	Pump connection thread mm
						20 °C	10 °C	0 °C	-20 °C	-30 °C						
<b>LAUDA Ecoline / Page 130</b>																
RE 212 J	-30 ... 200	-30 ... 200	0.01	III, FL	2.3	0.30 <sup>1</sup>	-	0.23 <sup>1</sup>	0.13 <sup>1</sup>	0.04 <sup>1</sup>	V	0.4	-	17	-	M16×1
RE 312 J	-30 ... 200	-30 ... 200	0.01	III, FL	2.3	0.30 <sup>1</sup>	-	0.23 <sup>1</sup>	0.13 <sup>1</sup>	0.04 <sup>1</sup>	V	0.4	-	17	-	M16×1
<b>LAUDA Proline / Page 132</b>																
PJ 12	30 ... 300	0 ... 300	0.01	III, FL	3.6	-	-	-	-	-	V	0.8	-	25	-	M16×1
PJ 12 C	30 ... 300	0 ... 300	0.01	III, FL	3.6	-	-	-	-	-	V	0.8	-	25	-	M16×1
PJL 12	30 ... 200	-40 ... 200	0.01	III, FL	3.6	-	-	-	-	-	V	0.8	-	25	-	M16×1
PJL 12 C	30 ... 200	-40 ... 200	0.01	III, FL	3.6	-	-	-	-	-	V	0.8	-	25	-	M16×1

# LAUDA Calibration thermostats

Power supply variants

Device type	Power supply V; Hz	Heater power max. kW	Loading max. kW	Plug code*	Cat. No.	Device type	Power supply V; Hz	Heater power max. kW	Loading max. kW	Plug code*	Cat. No.
<b>LAUDA Ecoline / Page 130</b>											
RE 212 J	115 V; 60 Hz	1.3	1.4	14	L001935	RE 312 J	115 V; 60 Hz	1.3	1.4	14	L001936
<b>LAUDA Proline / Page 132</b>											
PJ 12	100 V; 50/60 Hz	1.3	1.5	4	L001947	PJL 12	100 V; 50/60 Hz	1.3	1.5	4	L001949
PJ 12	115 V; 60 Hz	1.7	1.9	4	L001937	PJL 12	115 V; 60 Hz	1.7	1.9	4	L001939
PJ 12	200 V; 50/60 Hz	2.7	2.9	3	L001951	PJL 12	200 V; 50/60 Hz	2.7	2.9	3	L001953
PJ 12	208-220 V; 60 Hz	3.3	3.5	3	L001943	PJL 12	208-220 V; 60 Hz	3.3	3.5	3	L001945
PJ 12 C	100 V; 50/60 Hz	1.3	1.5	4	L001948	PJL 12 C	100 V; 50/60 Hz	1.3	1.5	4	L001950
PJ 12 C	115 V; 60 Hz	1.7	1.9	4	L001938	PJL 12 C	115 V; 60 Hz	1.7	1.9	4	L001940
PJ 12 C	200 V; 50/60 Hz	2.7	2.9	3	L001952	PJL 12 C	200 V; 50/60 Hz	2.7	2.9	3	L001954
PJ 12 C	208-220 V; 60 Hz	3.3	3.5	3	L001944	PJL 12 C	208-220 V; 60 Hz	3.3	3.5	3	L001946

<sup>1</sup>Pump output step 3



Nipples $\varnothing_e$	Bath volume max. L	Bath opening $\varnothing$ mm	Bath depth mm	Usable depth mm	Height top of bath mm	Dimensions (W x D x H) mm	Weight kg	Power supply V; Hz	Loading max. kW	Cat. No.	Device type
13	12.0	120	200	180	441	250 x 400 x 602	30.0	230 V; 50 Hz	2.3	L001917	RE 212 J
13	12.0	120	200	180	441	250 x 400 x 602	30.0	230 V; 50 Hz	2.3	L001918	RE 312 J
13	13.5	120	320	300	374	220 x 360 x 574	17.0	230 V; 50/60 Hz	3.7	L001923	PJ 12
13	13.5	120	320	300	374	220 x 360 x 630	17.0	230 V; 50/60 Hz	3.7	L001924	PJ 12 C
13	13.5	120	320	300	374	220 x 360 x 574	17.0	230 V; 50/60 Hz	3.7	L001925	PJL 12
13	13.5	120	320	300	374	220 x 360 x 630	17.0	230 V; 50/60 Hz	3.7	L001926	PJL 12 C

# ADDITIONAL EQUIPMENT

## Specific application examples

---

- Directly cooling of liquids in heating thermostats
- Cooling traps



**LAUDA**  
**ETK30**



# LAUDA Flow through coolers

## Flow through coolers for cooling heating thermostats up to $-30^{\circ}\text{C}$



### The perfect accessory for heating thermostats

LAUDA flow through coolers make it possible to work at room temperature, since they can be used to add a fully fledged, cooling thermostat to any heating thermostat with pump connections. Flow through coolers guarantee optimal temperature stability at all times and facilitate temperature conditions that can be reproduced anytime, since they replace ecologically unsound and cost-intensive cooling with tap water and allow work to be carried out without having to worry about fluctuations in flow through volumes and temperature of the cooling water.

### COOLING POWER Heat transfer liquid: Ethanol

#### Effective cooling power kW

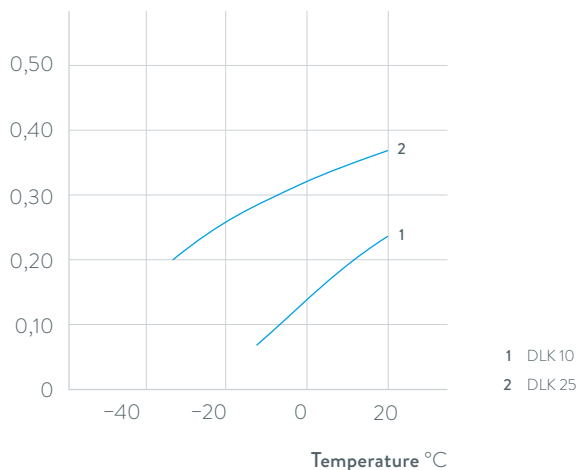

### Important functions

- Largely maintenance-free cooling units with heat exchangers made of stainless steel
- Connection with unscrewable nipples
- Low noise emissions
- No condensation or corrosion thanks to optimum insulation of cooled components

All technical data and power supply variants can be found in the ›Technical data‹ section.

More at [www.lauda.de/1778](http://www.lauda.de/1778)



### LAUDA Flow through coolers

Air-cooled, fully hermetical and therefore mostly maintenance-free cooling units with generously dimensioned heat exchangers are sure to impress with optimal insulation provided by polyurethane foam on all cooled parts in the interior of the flow through cooler – thus preventing condensation and corrosion.



# LAUDA Immersion cooler

Immersion cooler for constant cooling to  $-50^{\circ}\text{C}$



## The perfect addition to heating thermostats

LAUDA immersion coolers function using the classic principle of direct evaporation and serve as auxiliary coolers to quickly cool heating thermostats, water baths and cooling traps to temperatures below room temperature. The ETK 50 has its own temperature controller.

## COOLING POWER Heat transfer liquid: Ethanol

Effective cooling power kW

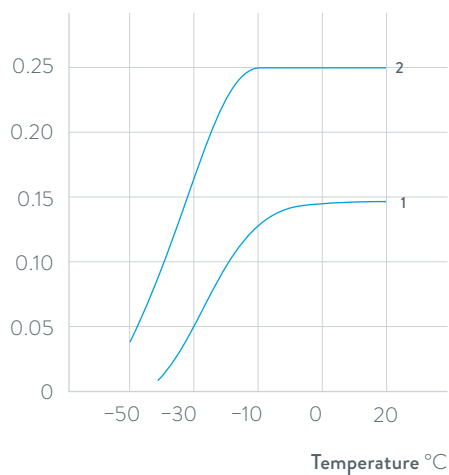

1 ETK 30  
2 ETK 50

## Important functions

- Stainless steel cooling coil
- Extremely flexible and well-insulated connecting hose to cold finger
- Injection of coolant directly into the cold finger for optimum efficacy
- Compact, space-saving design

All technical data and power supply variants can be found in the ›Technical data‹ section.

More at [www.lauda.de/1780](http://www.lauda.de/1780)



### LAUDA Immersion cooler

The compact immersion coolers ETK30 and ETK50 are equipped with cooling coils made of premium-quality, stainless steel. When used with heating thermostats, water baths and cooling traps, they facilitate the quick expansion of the temperature range downwards.



# LAUDA Additional equipment

## Device type overview

LAUDA Flow through coolers / Page 140

LAUDA Immersion coolers / Page 142



DLK 10



DLK 25



ETK 30



ETK 50

# LAUDA Additional equipment

## Technical data according to DIN 12876 standard

Device type	Working temperature range °C	Temperature stability ±K	Cooling output kW								
			20 °C	10 °C	0 °C	-10 °C	-20 °C	-25 °C	-30 °C	-40 °C	-50 °C
<b>LAUDA Flow through coolers / Page 140</b>											
DLK 10	-15 ... 150	-	0.22	-	0.20	0.10	-	-	-	-	-
DLK 25	-30 ... 150	-	0.33	-	0.28	0.25	0.22	-	0.20	-	-
<b>LAUDA Immersion coolers / Page 142</b>											
ETK 30	-30 ... 20	-	0.15	-	-	0.13	-	-	0.04	0.01	-
ETK 50	-50 ... 20	0.50	0.25	-	-	0.25	-	-	0.20	0.10	0.04



# LAUDA Additional equipment

## Power supply variants

Device type	Power supply V; Hz	Loading max. kW	Plug code*	Cat. No.	Device type	Power supply V; Hz	Loading max. kW	Plug code*	Cat. No.
-------------	--------------------	-----------------	------------	----------	-------------	--------------------	-----------------	------------	----------

### LAUDA Flow through coolers / Page 140

DLK 10	100 V; 50 Hz / 115 V; 60 Hz	0.2	14	L001975	DLK 25	100 V; 50 Hz / 115 V; 60 Hz	0.2	14	L001976
--------	-----------------------------	-----	----	---------	--------	-----------------------------	-----	----	---------

### LAUDA Immersion coolers / Page 142

ETK 30	100 V; 50 Hz / 115 V; 60 Hz	0.2	14	L001958
--------	-----------------------------	-----	----	---------

Dimensions (W x D x H) mm	Weight kg	Power supply V; Hz	Loading max. kW	Cat. No.	Device type
200 x 400 x 320	17.0	230 V; 50/60 Hz	0.2	L001963	DLK 10
290 x 540 x 330	33.0	230 V; 50 Hz	0.5	L001964	DLK 25
250 x 360 x 285	17.0	230 V; 50/60 Hz	0.2	L001955	ETK 30
460 x 410 x 270	33.0	230 V; 50 Hz	0.3	L001959	ETK 50

\*All data for the plug codes can be found on page 150

# LAUDA Heat transfer liquids

## For safe and reliable operation of your thermostats

**Highly accurate temperature control at extreme temperatures, reliability and long-term operational stability for a long service life of the thermostats.**

The right choice of heat transfer liquid is of critical importance for the safe and reliable operation of thermostats, circulation chillers or water baths. Thanks to our many decades of experience, we are able to offer optimum heat transfer liquids for LAUDA thermostats and other brands. Prices of heat transfer liquids can be found in our price list, which we will gladly send you on request.

Designation	Open / half-open systems °C						Closed systems with cold oil overlay (Integral XT) °C						Cat. No. 5I/10I/20I
	-100 °C	-50 °C	0 °C	100 °C	200 °C	300 °C	-100 °C	-50 °C	0 °C	100 °C	200 °C	300 °C	
Aqua 90			5 °C		90 °C								LZB 120/LZB 220/LZB 320
Kryo 95 Silicone oil	-95 °C				60 °C		-95 °C					160 °C	LZB 130/LZB 230/LZB 330
Kryo 70 Silicone oil							-70 °C					220 °C	LZB 127/LZB 227/LZB 327
Kryo 65							-65 °C					140 °C	LZB 118/LZB 218/LZB 318
Kryo 60 Silicone oil		-60 °C			60 °C								LZB 102/LZB 202/LZB 302
Kryo 51 Silicone oil		-50 °C											LZB 121/LZB 221/LZB 321
Kryo 40			-40 °C		60 °C								LZB 119/LZB 219/LZB 319
Kryo 30			-30 °C		90 °C				-30 °C			90 °C	LZB 109/LZB 209/LZB 309
Kryo 20 Silicone oil			-20 °C										LZB 116/LZB 216/LZB 316
Therm 160				60 °C									LZB 106/LZB 206/LZB 306
Therm 180 Silicone oil				0 °C									LZB 114/LZB 214/LZB 314
Therm 250 Silicone oil				50 °C									LZB 122/LZB 222/LZB 322
Ultra 240 Silicone oil				80 °C									LZB 108/LZB 208/LZB 308
Ultra 350				30 °C					30 °C				LZB 107/LZB 207/LZB 307



# LAUDA Accessories

## Individual solutions, down to the finest detail

### Optimized for your requirements

Operating constant temperature equipment often requires the use of vital accessory components. Only by using the right sampling frames, connecting parts, varied tubing connectors, distributors or interface modules, can applications be smoothly implemented.

LAUDA's comprehensive range of accessories offers you the ideal accompaniment to your complete solution, proven many times over, all from a single source.

**Cooling of heating thermostats** – Cooling coil sets, solenoid valve/cooling water regulation, regulated high-temperature coolers

**Level control** – Constant level device, automatic filling device, Variocool flow control instrument, separating plate with jet pipe and suction pipe, plunger

**Connecting plugs, connecting cables**

**Bath covers** – Stainless steel bath covers, bath cover sets, stainless steel gable covers

**Racks, platforms, lifting platforms** – Polycarbonate/stainless steel hanging racks up to 100 °C, test tube in polypropylene (up to 95 °C)/stainless steel (up to 150 °C), inserts for calibrating thermostats, lifting platforms, accessories for notch bending test/pour point determination

**Hoses** – Polymer hoses (insulated/uninsulated), reinforced EPDM hoses, insulating hoses for subsequent insulation, EPDM cooling water hoses, stainless steel hose clips, metal hoses with simple heat/cold insulation/for heat and cold/with multi-layered insulation

**Adapters** – Pump connector sets, hose connectors, quick couplings for cooling water connection, distributors, Integral XT bypass, ball cocks, screw caps, graphite seals

**Additional pumps** – Proline Kryomats (ex-works only), booster pump

**Interface modules, remote controls** – Interfaces, Integral T remote control

**Operation and measurement in ex-zones** – Command EX i remote control unit, barrier boxes for connection to external temperature sensors

**Temperature probes** – Platinum resistance thermometers, connecting plugs, connecting cables, compression fittings

**Other accessories** – Backlight for viscothermostats, bath edge and window heating (ex-works only), castor base with castors/castor sets



### **LAUDA Accessories**

LAUDA components offer you the fitting complement to your application – from very small to very large. Therefore you can easily personalize your application and meet every requirement – in the usual LAUDA quality.

# Power plugs

## Overview

Image	Plug code	Description	Image	Plug code	Description	Image	Plug code	Description
	2	CEE7/7 angled (EU, Schuko)		3	NEMA 6-20P (USA)		4	NEMA 5-20P (USA)
	5	GB2099 (CN)		6	BS1363 angled (UK)		7	IEC 60309, (blue), Caravan
	8	SEV 1011, SEV 5934/2 (CH, T23)		9	AS/NSZ 3112 (AUS)		10	NBR 14136 (BR)
	11	C19 H05VV-F3G 1,5 mm <sup>2</sup> (EU)		12	C19 SJT, 3 x 14 AWG (USA)		13	H05VV-F3G 2,5mm <sup>2</sup>
	14	NEMA 5-15P (USA)		15	H07RN-F4G 2,5 mm <sup>2</sup>		16	HAN-modular, Type 6B
	17	CEE7/7 straight (EU, Schuko)		18	H05VV-F4G 1,5mm <sup>2</sup>		19	H07RN-F4G 4 mm <sup>2</sup>
	20	H07RN-F4G 1,5 mm <sup>2</sup>		21	IEC 60309, 5-pin, CEE, red, 16 A		22	IEC 60309, 5-pin, CEE, red, 32 A
	23	IEC 60309, 5-pin, CEE, red, 63 A		24	Type CA 3 LS			
	25	NEMA 5-15P (Japan)		26	SEV 1011, SEV 5934/2 (CH, T12)			

